

# **Structural Materials Development for MFE and IFE**

**S.J. Zinkle**

**Oak Ridge National Laboratory**

**FESAC Development Path  
Strategic Planning Meeting**

**October 28, 2002**

**LLNL**

# Outline/topics to be addressed

- What options could be possible for a 35-year Demo?
  - ODS steels? Vanadium? SiC/SiC ?
    - Why not Ti alloys, superalloys, etc.
  - Summary of coolant and breeding material options
- Relative technological maturity of various classes of materials and coolants
- How much could the rate of development be accelerated with more funding?
- Role of an intense neutron source in fusion development
  - Primer on fission vs. fusion neutron damage characteristics (<10 dpa fusion neutrons are not very useful, thanks to RTNS-II program and modeling advances)
  - Summary of proposed IFMIF neutron source facility
  - Technological status of IFMIF
  - Alternative neutron sources (GDT, LEDA, laser point neutron source, etc.)
  - How much IFMIF do you need and when? What is the mission of IFMIF?
  - What materials facilities are needed besides an intense neutron source
  - What is the role of multiscale modeling on accelerating fusion component development (is a CTF needed?--M. Rosenbluth email 10/22/02); can IFMIF + ITER blanket testing provide sufficient info for constructing Demo? (Q#2, p. 7 of 10/24 draft)
- MFE and IFE materials: Commonality and disparateness

## Structural Materials will Strongly Impact the Technological Viability, Safety, and Economics of Fusion Energy

- Key issues include thermal stress capacity, coolant compatibility, safety, waste disposal, radiation damage effects, and safe lifetime limits
- The 3 leading candidates are ferritic/ martensitic steel, V alloys, and SiC/SiC (based on safety, waste disposal, and performance considerations)
  - Commercial alloys (Ti alloys, Ni base superalloys, refractory alloys, etc.) have been shown to be unacceptable for fusion for various technical reasons

### Summary of several recent fusion energy blanket concepts

Structural Material	Coolant/Tritium Breeding Material					
	Li/Li	He/PbLi	H <sub>2</sub> O/PbLi	He/Li ceramic	H <sub>2</sub> O/Li ceramic	FLiBe/FLiBe
Ferritic steel						
V alloy						
SiC/SiC						

# Fusion Materials Development

- Five categories of structural materials were investigated in the early stages of the fusion materials program (beginning in 1975)
  - Path A: austenitic stainless steel--determined to be an unsuitable candidate for Demo and beyond due to radiation stability issues (swelling, He embrittlement), poor thermal stress capacity; Mn-stabilized steels also had safety (decay heat) issues
  - Path B: superalloys (discontinued due to radiation embrittlement above 10 dpa)
  - Path C: Reactive and refractory metals & alloys--led to **V alloy** development; Ti alloys were evaluated and discontinued due to radiation stability and tritium inventory issues; Mo and W alloys have some potential but would require large R&D investment to solve existing embrittlement and joining challenges
  - Path D: Innovative concepts, including multilayered materials, ceramic composites, etc.--led to **SiC/SiC composites**
  - Path E: **Ferritic/martensitic steels** (added in late 1970s when superalloys were abandoned)

# Structural Materials

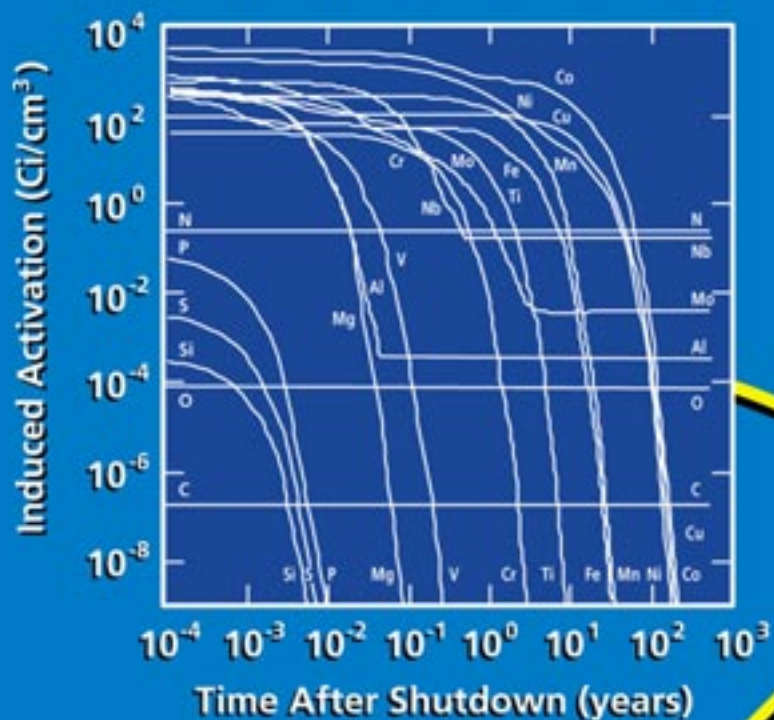

**SiC**  
**V Cr Ti Si**  
**Fe Cr W V Ta**

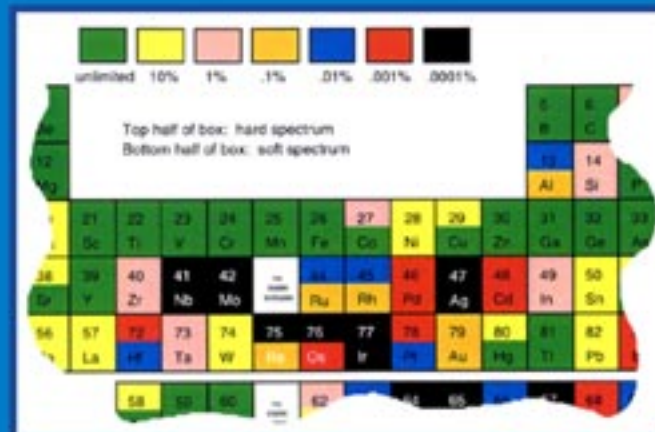

**Class C Waste Disposal**

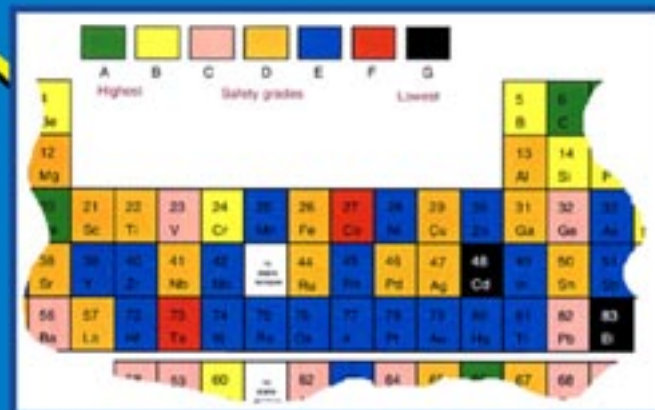

**Safety**

# Reduced Activation Ferritic/martensitic Alloys Developed by Fusion have Properties Comparable or Superior to Commercial (high-activation) Alloys

Comparison of thermal  
creep-rupture strengths

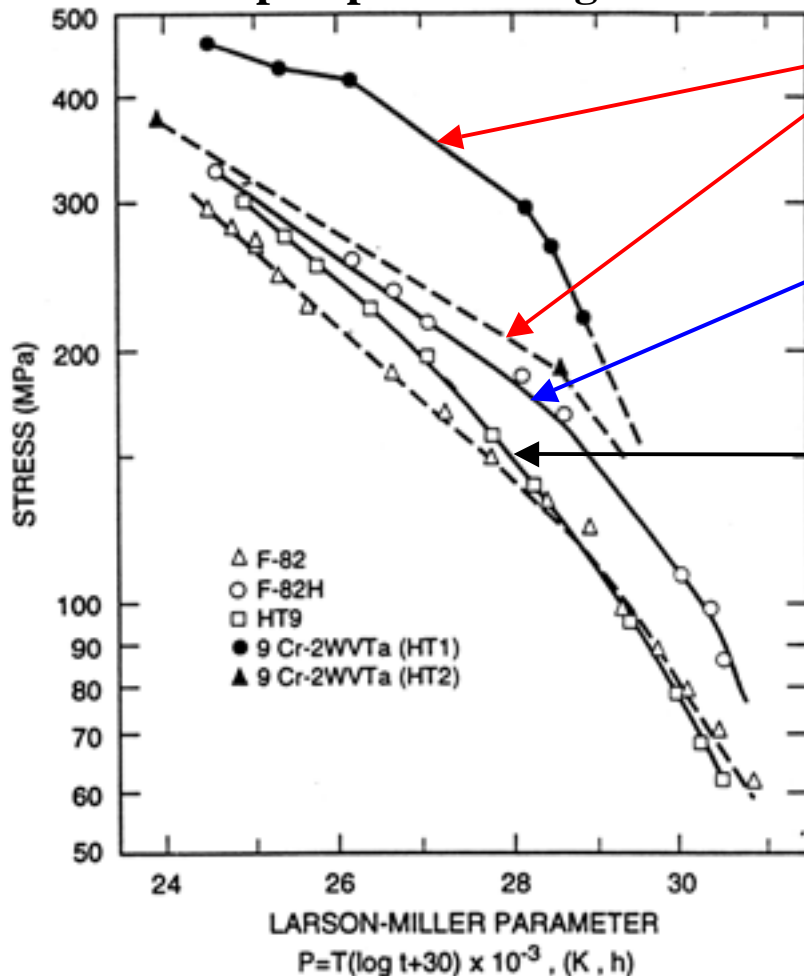

reduced activation steels (small heats)

IEA fusion reduced activation steel

Commercial ferritic steel (HT9)

*Fusion-developed steels also  
have superior tensile strength,  
fracture toughness, and  
thermal conductivity*



# Comparison of the Design Window for Nb1Zr and V4Cr4Ti

## Design Window for Nb-1Zr

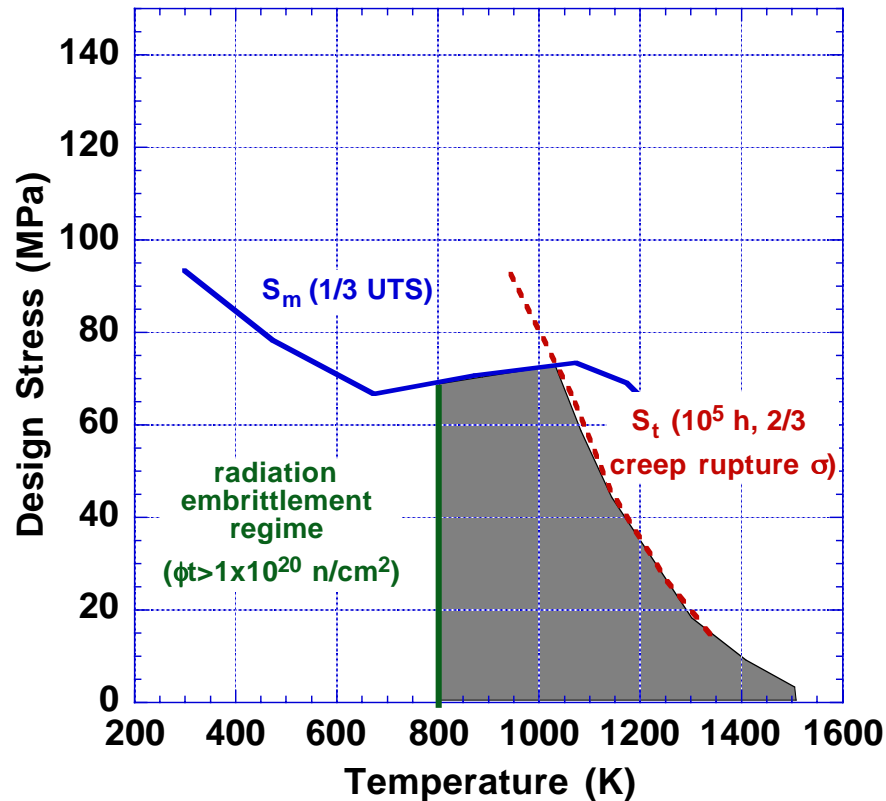

## Design Window for V-4Cr-4Ti

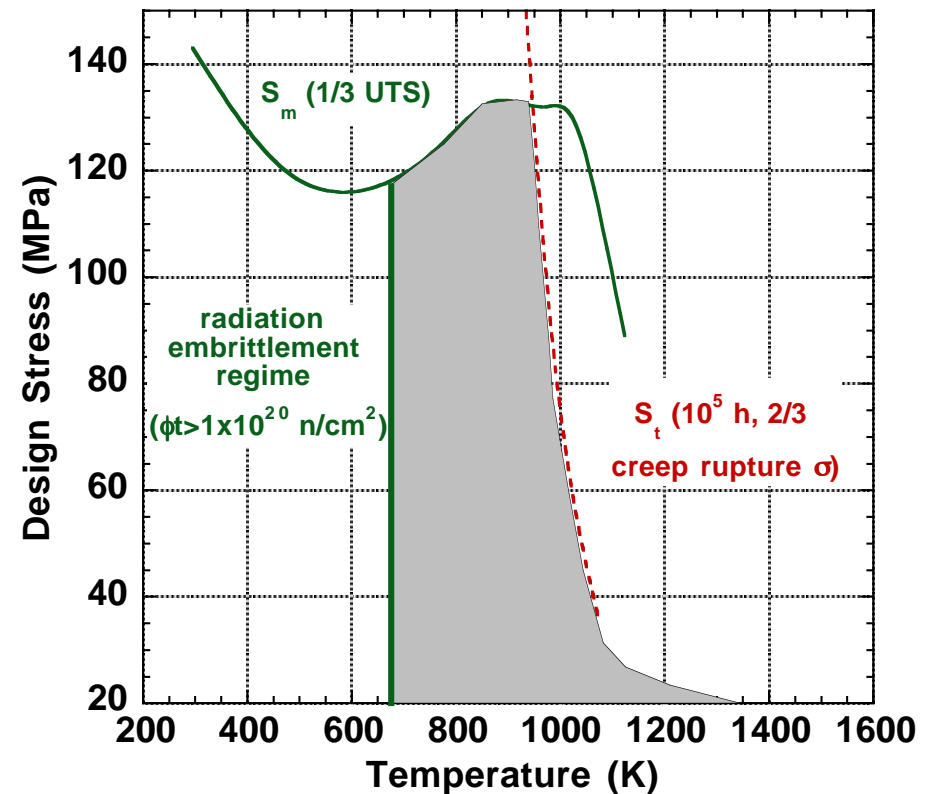

- V4Cr4Ti offers ~factor of two higher stress capability than Nb1Zr

# Key Cross-cutting phenomena for Fusion Structural Materials

Mech. props

F/MS	V	Cu	SiC	Phenomena, Issues, Comments
***	***	***	-	hardening and nonhardening embrittlement including underlying microstructural causes and the effects of helium on fast fracture
**	**	**	-	flow localization, consequences and underlying microstructural causes
***	***	*	*	helium effects on high temperature deformation and fracture, and development of improved multiphase alloys for helium control
**	**	**	**	thermal and irradiation creep
**	**	**	**	fatigue
**	***	*	*	hydrogen and interstitial impurity effects on deformation and fracture
*	***	-	**	coatings, multilayers, functionally graded materials
**	**	**	***	swelling and general microstructural stability
**	***	**	***	welding, joining and processing issues
		*	***	physical properties, e.g. thermal conductivity
			***	permeability of gases
**	**	**	**	erosion, chemical compatibility, bulk corrosion, cracking, product transport

- Much of the R&D on RAFMs, V alloys, etc. can guide the development of advanced ferritic steels



# Scientific Research Program Requires a Technological “Rudder” to Maintain Optimal Progress

- Current stage (scientific discovery): Science-based investigations of fundamental materials phenomena
  - Heavy reliance on modeling
- Research techniques evolve as our understanding improves
  - SiC/SiC example: heavy reliance on inexpensive screening tests during initial stage of research (3 point bend bars); current evolution to tensile and fracture toughness test program

# Stress-Temperature Design Window for Unirradiated Type 316 Stainless Steel

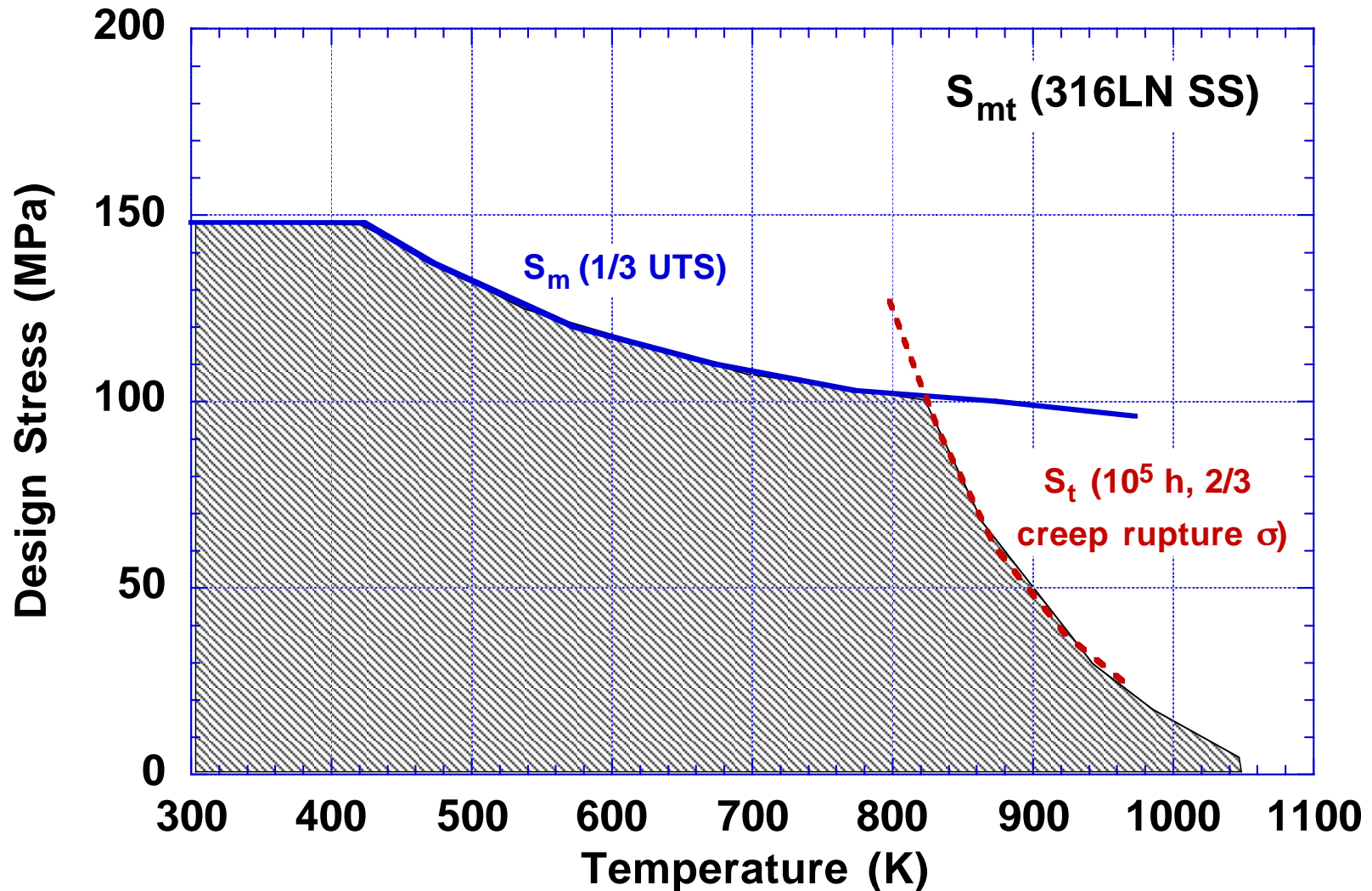

- Type 304 SS has  $\sim 30^\circ\text{C}$  lower temperature capability than 316 SS

# Current Development Status of Structural Materials

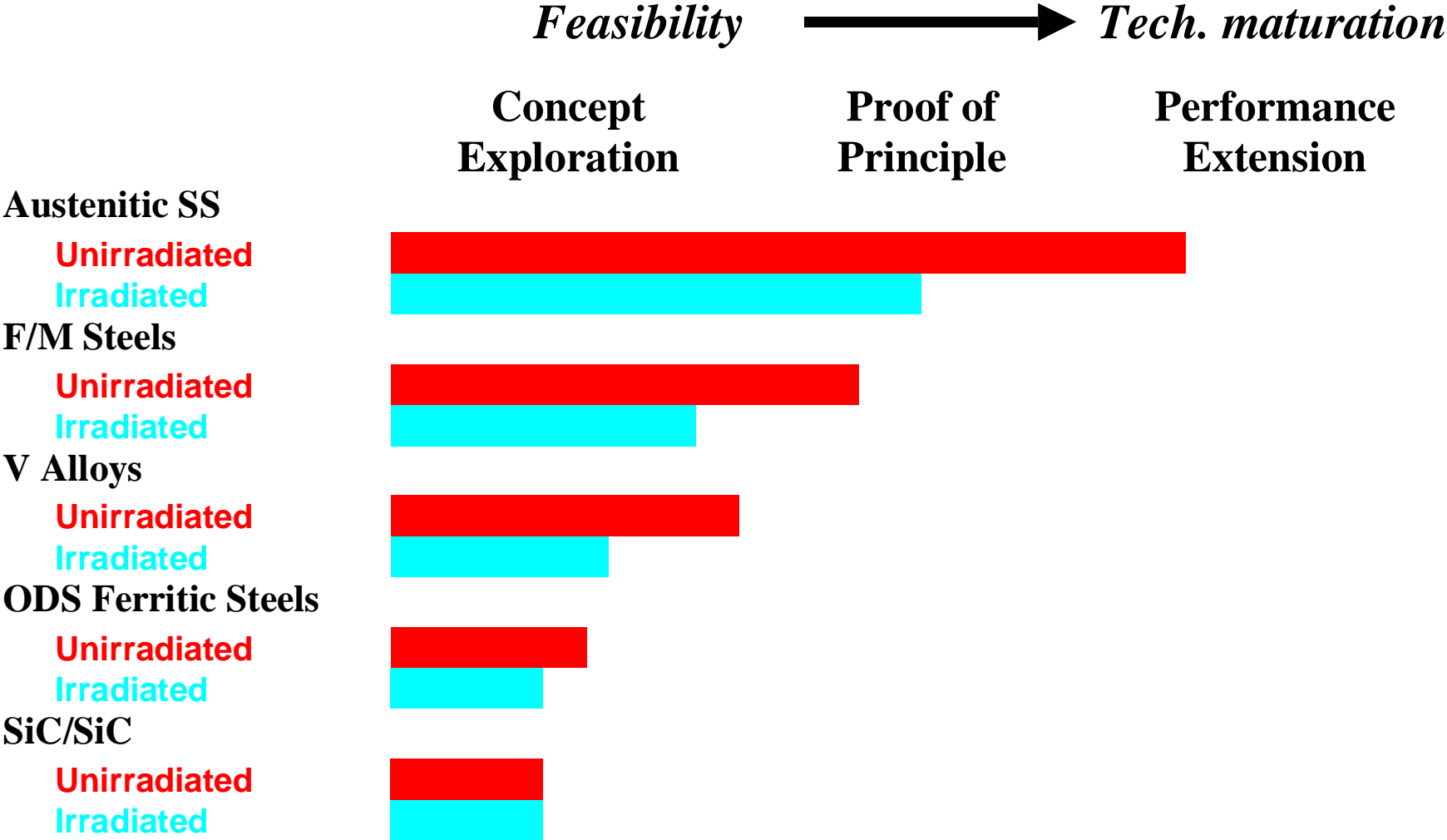

# Snapshot of research activities on V alloys examining key feasibility issues

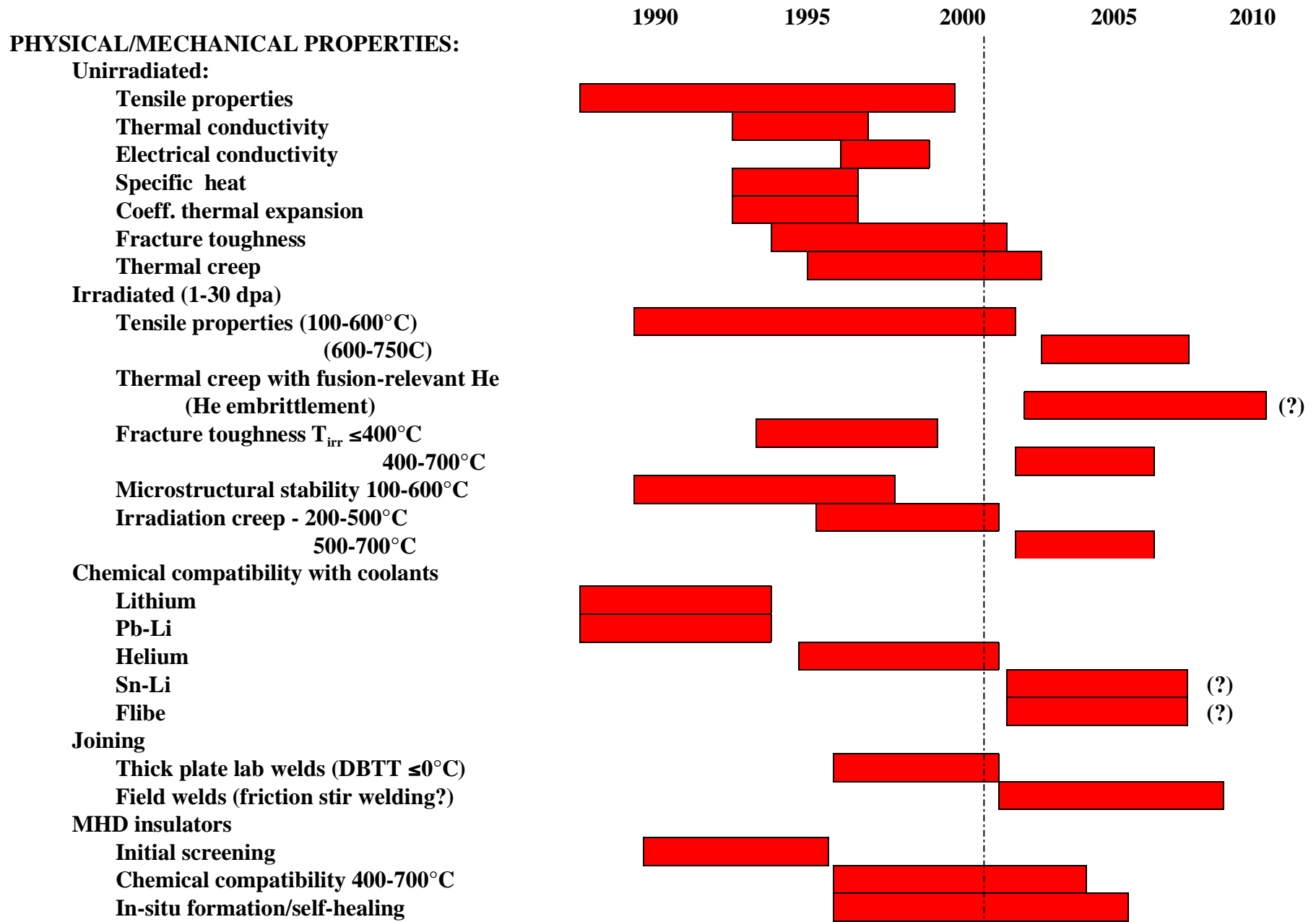

# Low uniform elongations occur in many FCC and BCC metals after low-dose irradiation at low temperature

Uniform elongation of neutron-irradiated V-4Cr-4Ti

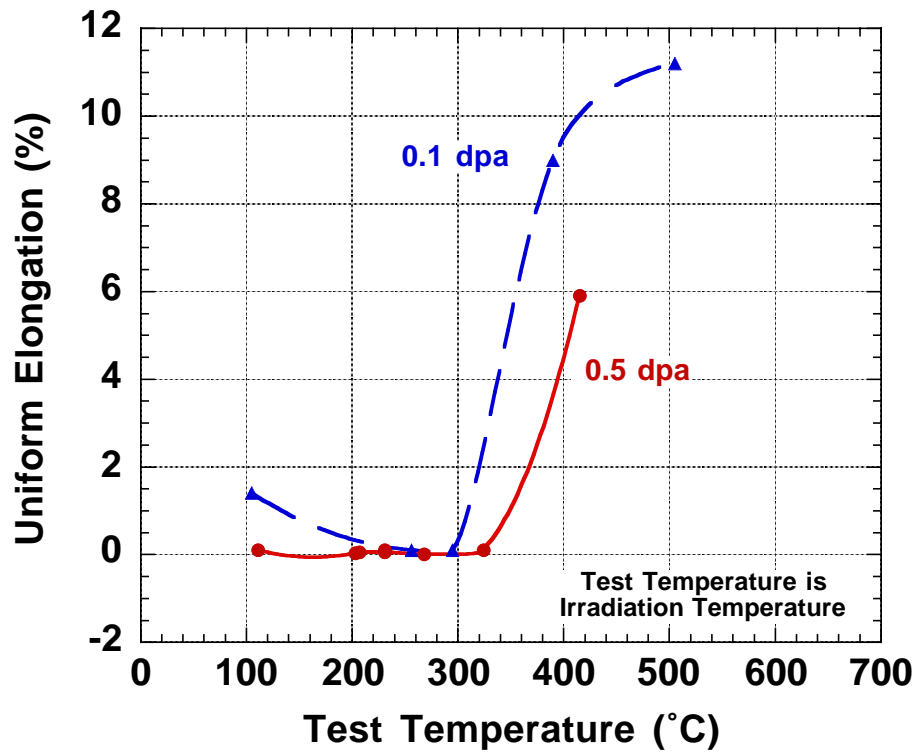

Uniform elongation of neutron-irradiated GlidCop Al25 and CuCrZr

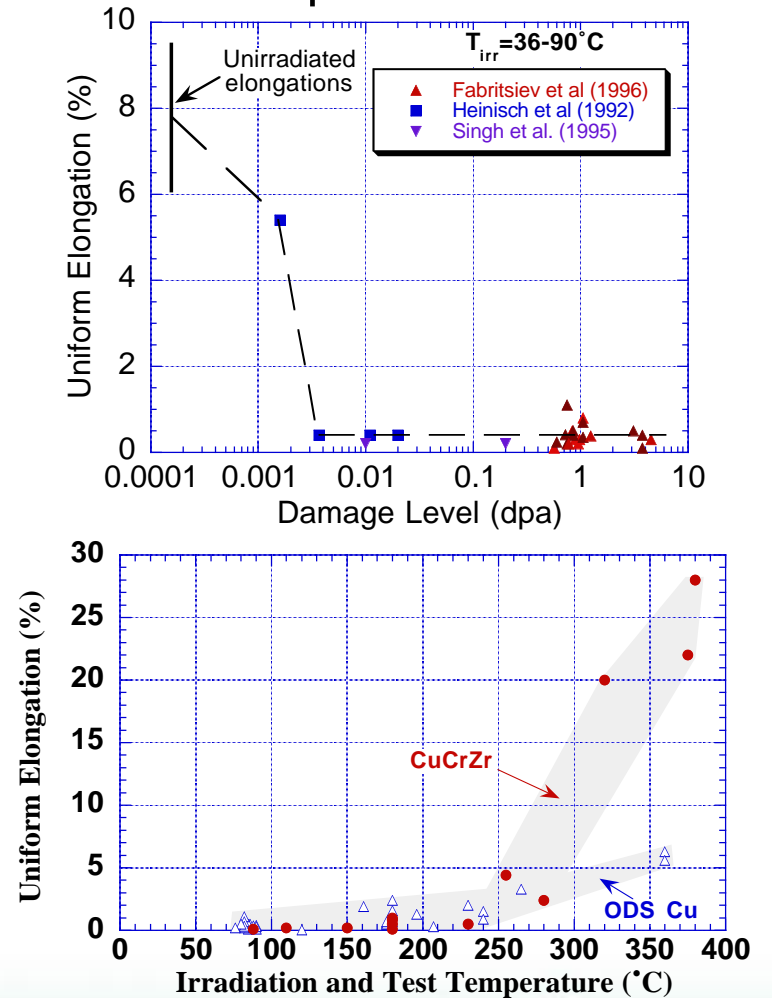

# Swelling resistant alloys have been developed via international collaborations

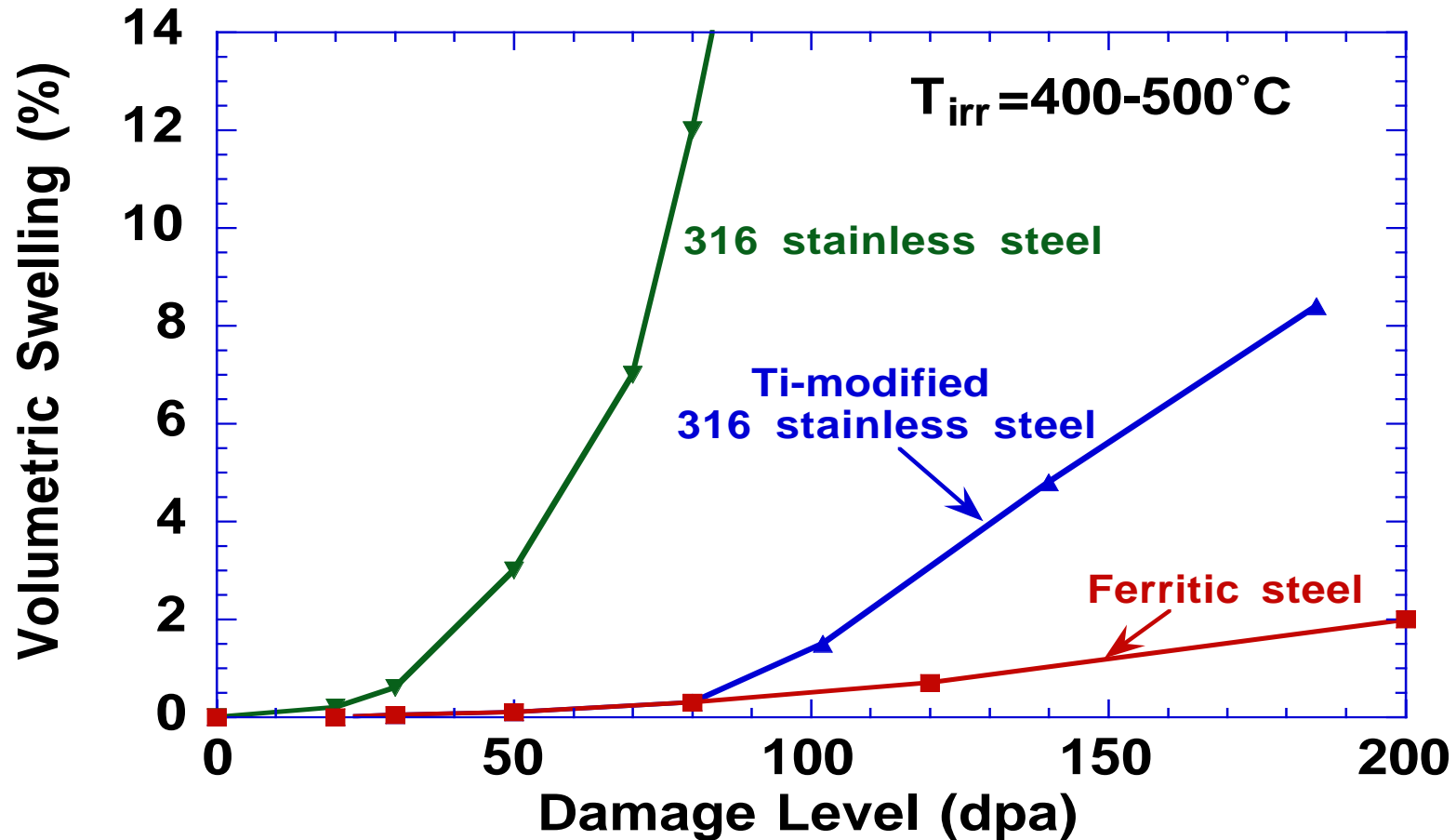

- Lowest swelling is observed in body-centered cubic alloys (V alloys, ferritic steel)
- Materials science strategy used for stainless steel can be applied to new alloys
- A key issue regarding BCC alloys is radiation embrittlement



# Low Activation Ferritic Steels for First Wall/Blanket Structures

## *Advantages*

- Well-developed technology for nuclear and other advanced technology applications
- Fusion materials program has developed low activation versions with equivalent or superior properties
- Resistant to radiation-induced swelling and helium embrittlement
- Compatibility with aqueous, gaseous, and liquid metal coolants permits range of design options

## *Issues*

- Upper operating temperature limited to ~ 550°C by loss of creep strength
- Potential for radiation-induced embrittlement at temperatures <400°C
- Possible design difficulties due to ferromagnetic properties

## **CURRENT APPROACH**

### *Expand Low Temperature Operating Window*

- Pursue collaborative fission reactor irradiation program with EU and Japan
  - Investigate micro- mechanics of fracture and radiation-induced reductions in fracture toughness
  - Understand the role of helium on fracture and crack propagation
  - Develop Master Curve approach to examine deformation modes and fracture resistance

### *Expand High Temperature Operating Window*

- Explore potential of nanocomposited ferritic (NCF) materials to expand upper operating temperature to ~800°C
  - Develop radiation-stable, high toughness microstructures

3-D atom probe image; clusters of ~100 atoms of Y, Ti, and O responsible for high strength of NCF materials

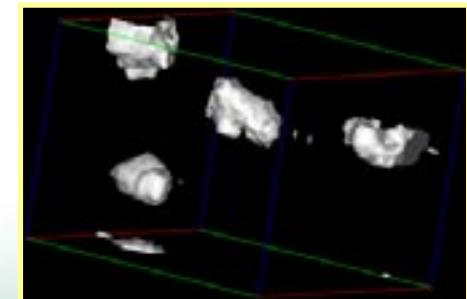

UT-BATTELLE

# Key Feasibility Issues for Ferritic Steels

- Verify ferromagnetic structures are acceptable for MFE
- Expand low temperature operating limit (experiments and physical modeling, using fracture mechanics)
  - Effect of He on low temperature (<400°C) embrittlement
- Expand high-temperature and dose limits
  - Alloy development, including dispersion strengthened alloys
  - Effect of He on creep rupture
- Resolve system-specific compatibility issues (T barrier development, chemical compatibility with coolant/breeder, etc.)

*US program is focusing on items 2 & 3 (EU and JA programs are investigating system-specific items 1 and 4)*

# Prospects for Advanced Ferritic Steels

- Why do we need advanced alloy systems?
  - Increased thermodynamic efficiency (with high availability)
  - limitations of current alloy systems
- What are the potential candidate advanced alloy systems that are being explored?
  - Tempered Martensitic Steels - evolutionary
  - Nanocomposited Ferritic Alloys - revolutionary

# New Nanocomposited 12YWT Ferritic Steel Exhibits Excellent High Temperature Creep Strength

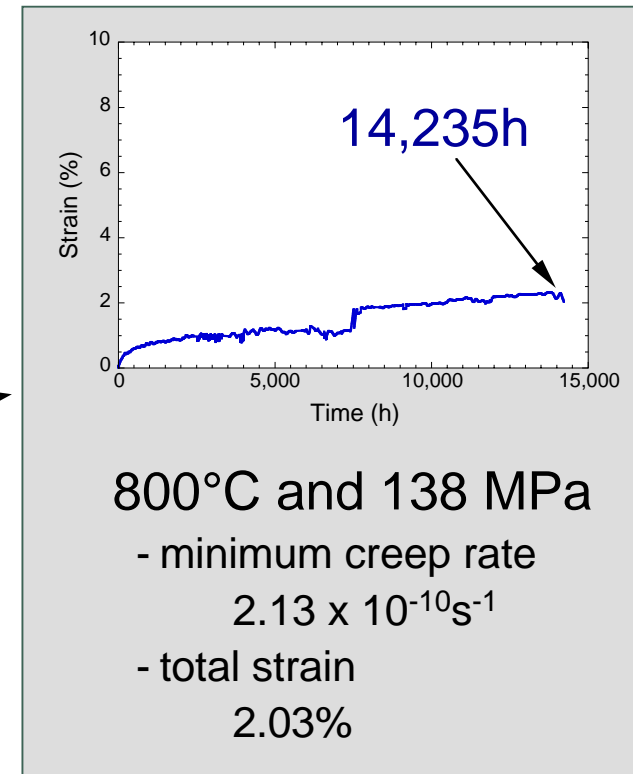
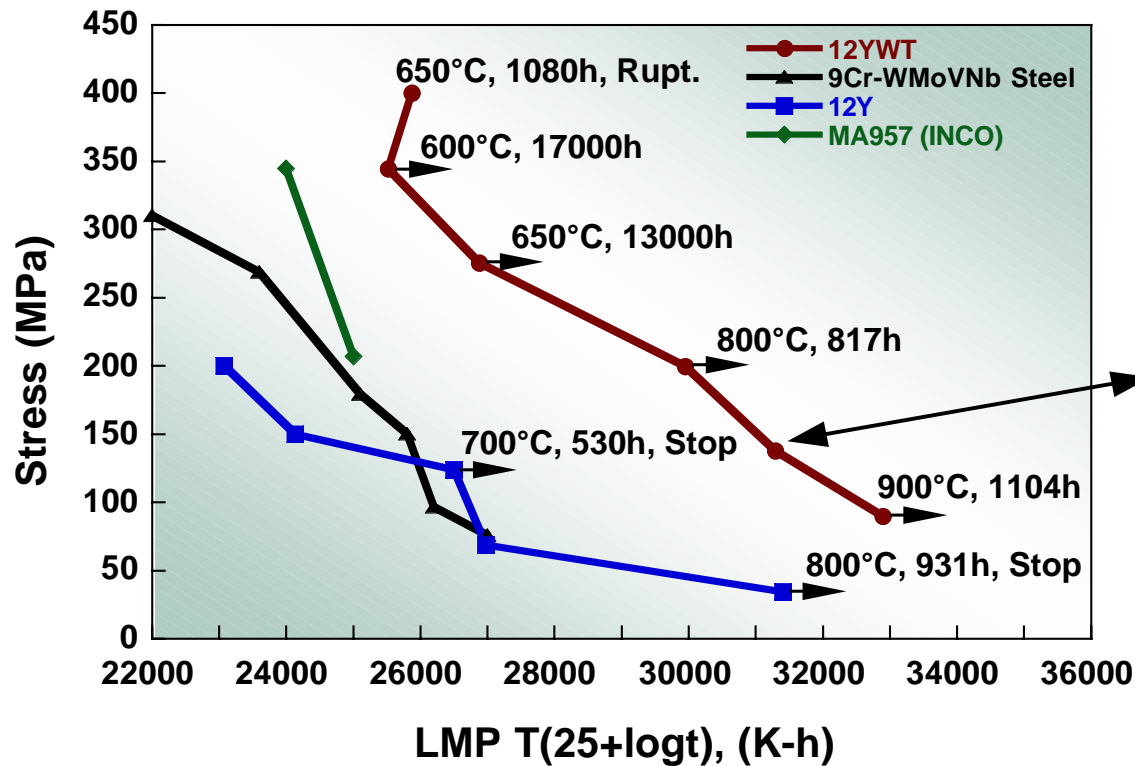

- Time to failure is increased by several orders of magnitude compared to existing steels, including conventional oxide dispersion strengthened steel (MA957)
- Potential for increasing the upper operating temperature of iron based alloys by  $\sim 200^\circ\text{C}$

# Vanadium Alloys are Most Attractive for Li Cooled/Breeder Blanket Systems

- **Performance Potential**

- High Wall Load/Power Density
- High Operating Temperature and Thermodynamic Efficiency
- Low Activation/Potential Recycle

- **Research Emphasis**

- Development of V/Li MHD Insulator Systems
- Investigation of Effects of Irradiation on Fracture Properties
- Kinetics of Interstitial Impurity Pick-up and Effects on Properties

- **Feasibility Issues**

- Insulator Coatings to Mitigate MHD Effects in Li/V System
- Establish operating temperature window
  - Effects of He and displacement damage on properties
  - High temperature creep behavior
- Impurity Interactions from Environment, e.g. Oxidation

Thermal Creep of  
V-4% Cr-4% Ti at  
700°C

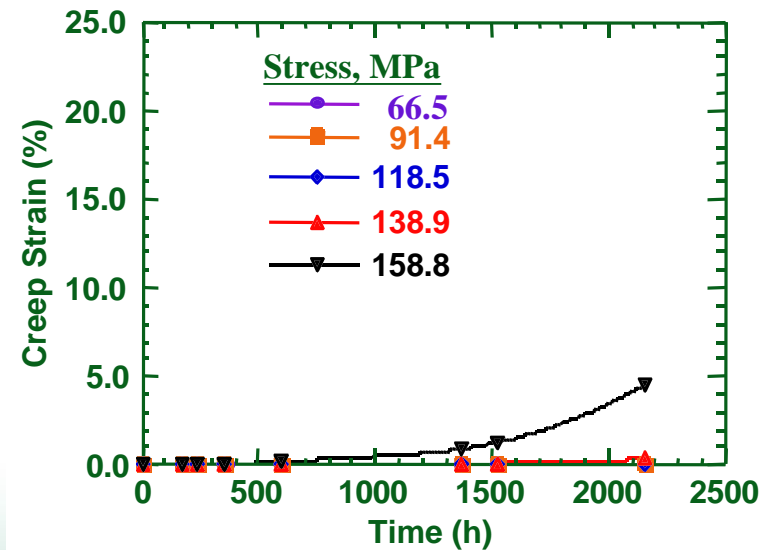

# Development of SiC Composites for Fusion Reactor Structural Applications: Difficult and High Risk but High Payoff

- **SiC Composites Offer**

- Low radioactivity and afterheat (eases waste disposal and safety concerns)
- High operating temperatures (greater thermodynamic efficiency)

- **The Feasibility Issues**

- Thermal conductivity is reduced by irradiation
- Little is known about mechanical property response to irradiation
- Technology base for production, joining, design of large structures, is very limited

- **Research Approach**

- Understand the magnitude and cause of radiation effects on key properties such as thermal conductivity and strength

- Design composite structures (fiber, fiber-matrix interphase and matrix) with improved performance
- Through SBIRs work to develop the required technology base

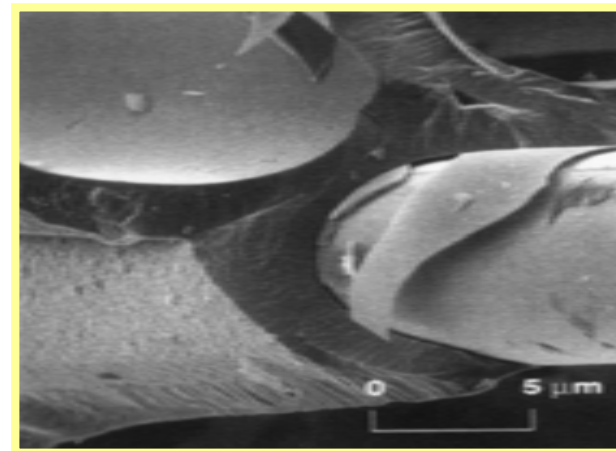

**Silicon carbide composites offer engineerability for extreme environments through tailoring of the fiber, matrix, and interphase structures**



# We Now Have First Radiation-Resistant SiC Composite

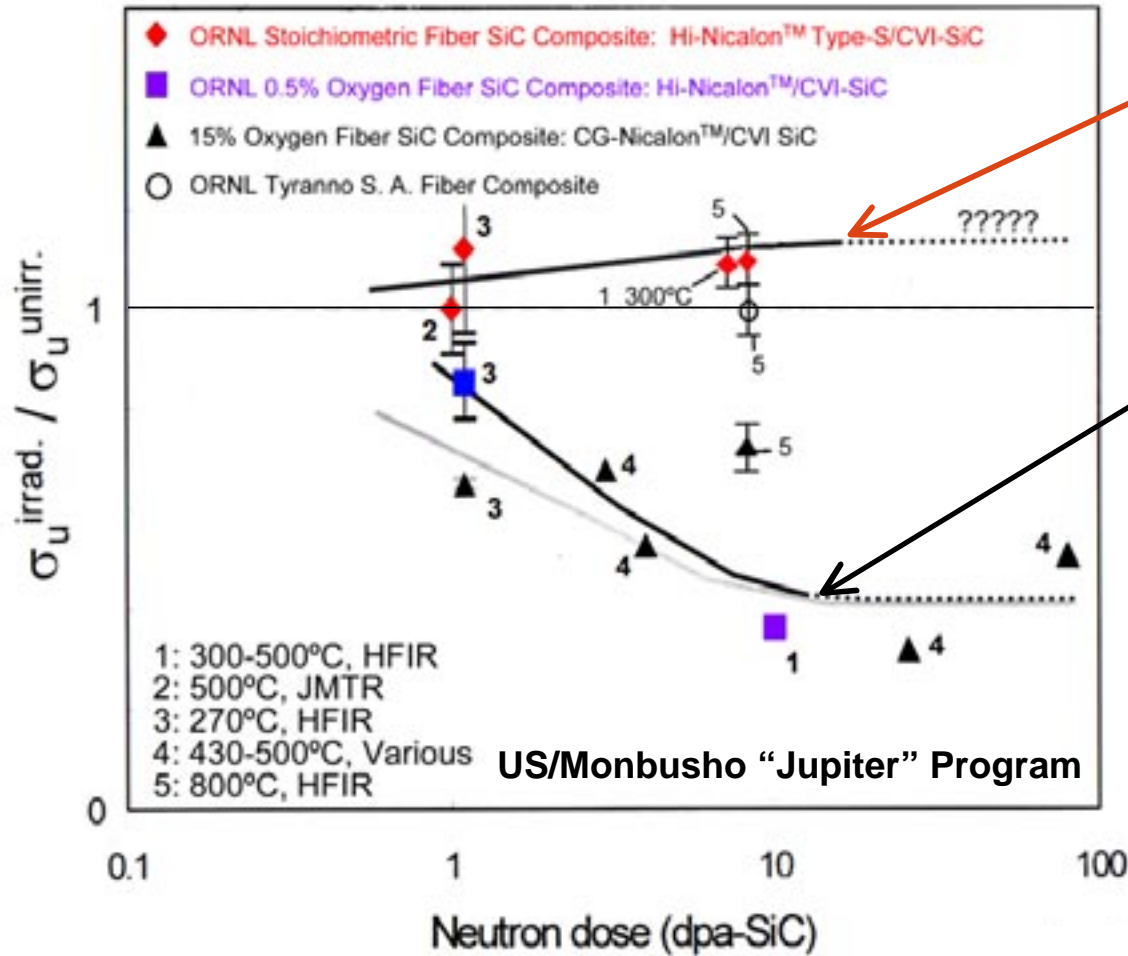

Bend strength of irradiated "advanced" composites show **no degradation** up to 10 dpa

1st- and 2nd generation irradiated SiC/SiC composites show **large strength loss** after doses >1 dpa

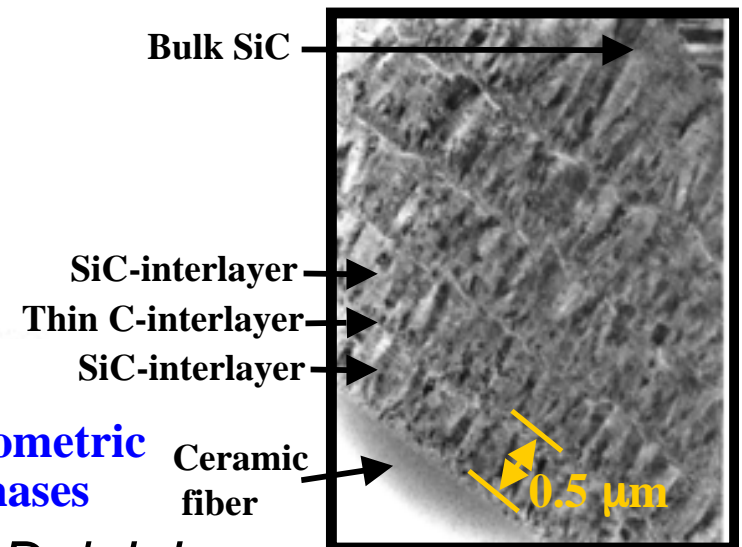

Improved performance is due to development of stoichiometric crystalline SiC fibers and advanced fiber/matrix interphases

Future work: advanced matrix infiltration R&D; joining; hermetic coatings; SiC/graphite composites, etc.

# Fusion materials research must rely heavily on modeling and surrogate experiments due to inaccessibility of fusion-relevant operating regime

- Extrapolation from currently available parameter space to fusion regime is much larger for fusion materials than for plasma physics program
- An intense neutron source such as IFMIF is needed to develop fusion structural materials

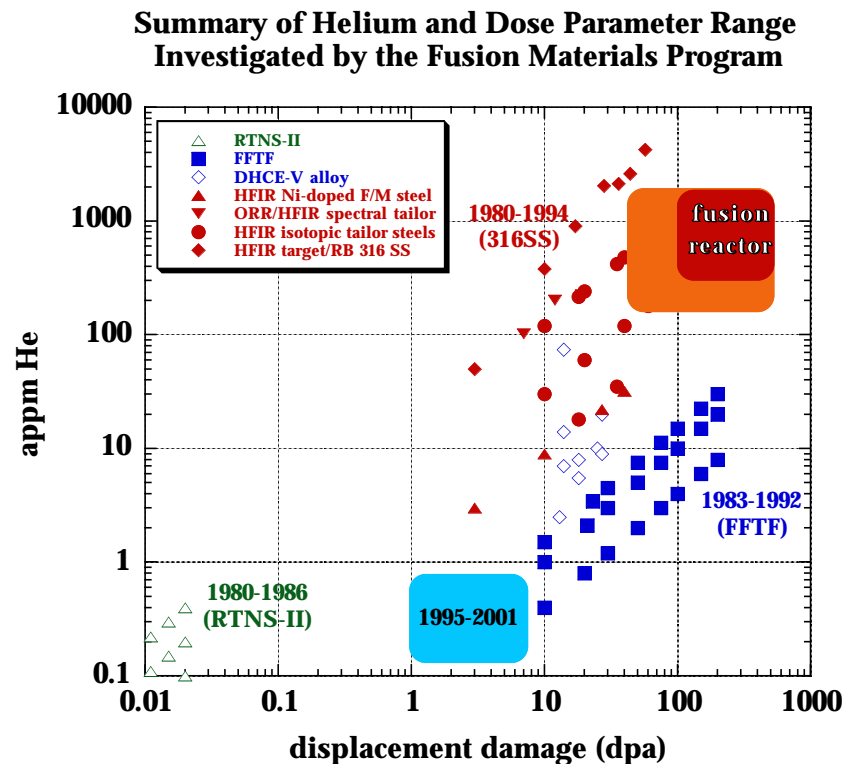

# Why is He/dpa ratio an important parameter for fusion materials R&D?

- He generation can alter the microstructural evolution path of irradiated materials
  - Cavity formation
  - Precipitate and dislocation loop formation

He bubbles on grain boundaries can cause severe embrittlement at high temperatures

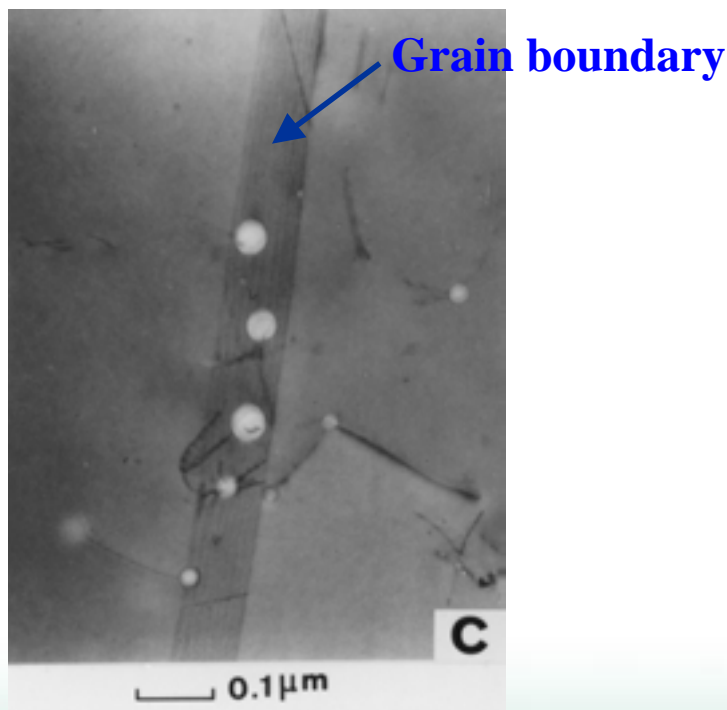

Swelling in stainless steel is maximized at fusion-relevant He/dpa values

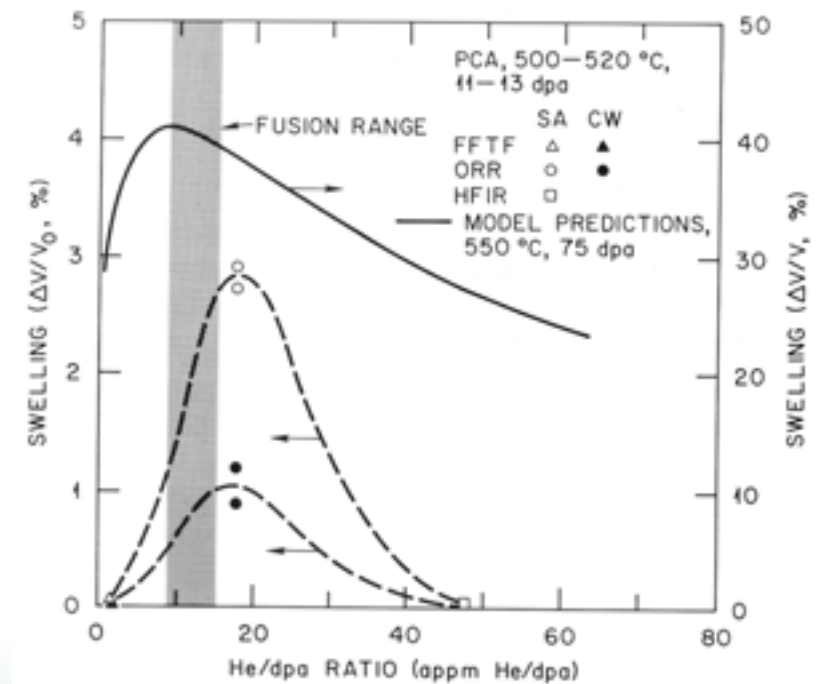

# Multidisciplinary Fusion Materials Research has Demonstrated the Equivalency of Displacement Damage Produced by Fission and Fusion Neutrons

Similar defect clusters produced by fission and fusion neutrons as observed by TEM

Fission  
(0.1 - 3 MeV)

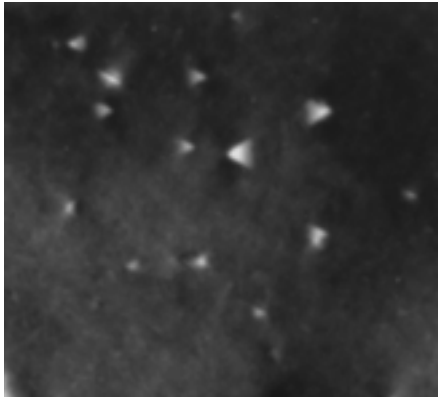

Fusion  
(14 MeV)

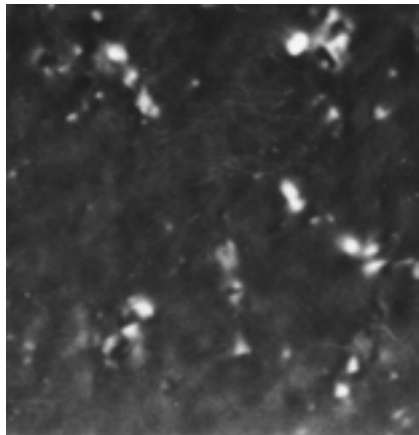

MD computer simulations show that subcascades and defect production are comparable for fission and fusion

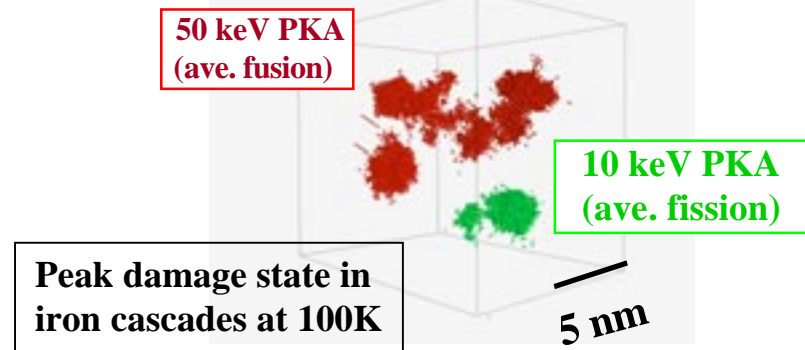

Similar hardening behavior confirms the equivalency

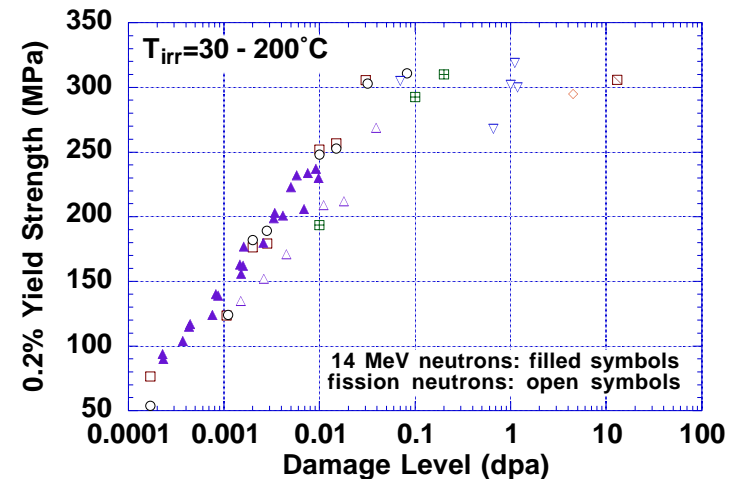

*A critical unanswered question is the effect of higher transmutant H and He production in the fusion spectrum*

# Role of neutron sources in fusion materials development

- Radiation damage is consistently considered by materials experts to be the rate-controlling step in fusion materials development
  - Additional parameters such as joining, compatibility, thermophysical properties are important, but critical data needed to evaluate feasibility can be obtained more rapidly compared to radiation effects studies
- Evaluation of fusion radiation effects requires simultaneous displacement damage and He generation, with He concentrations above 100-1000 appm
  - Low dose (<10 dpa) irradiation studies at fusion-relevant He/dpa have limited role
- Evaluation of mechanical properties of a given material at a given temperature requires a minimum volume of  $\sim 10 \text{ cm}^3$  with flux gradients  $< 20\%/ \text{cm}$ 
  - Current miniaturized specimen geometries used by fission and fusion materials communities is approaching theoretical volume limits for mechanical property measurements
  - Innovative alternative neutron sources such as the LBL DT source and the laser fusion point source would be useful for investigating microstructural stability of irradiated materials, but do not replace the need for a moderate-volume intense neutron source such as IFMIF



# Why do we need a dedicated Fusion Neutron Source?

---

- Existing irradiation facilities only partly fulfill the needs for materials development for DEMO reactors ( $\approx 150$  dpa):
  - Fission reactors: large irradiation volumes, appropriate n-flux, but n-spectrum not adequate
  - Accelerators (e.g. p, He): appropriate dpa & gas production rates, favorable conditions for in-situ tests, but small volumes
- ITER testing is limited because fluence accumulation is restricted to  $\leq 10$  dpa and the mode of operation is very different from DEMO (e.g. low temperature, strongly pulsed operation)

However, it is a valuable test bed for integral testing of components like TBM's in the low fluence regime.

- ➔ There is presently no irradiation source that combines
  - fusion similar spectrum
  - high fluence for accelerated materials testing
  - sufficiently large test volume



# Overview of Fission, Spallation, and d-Li Neutron Sources for Fusion Materials R&D

Neutron Source	Advantages	Disadvantages
Fission Reactors	<p>Well-characterized spectra</p> <p>Allows medium-high damage regimes to be investigated in bulk specimens</p> <p>Operating funds provided by multiple users (non-fusion)</p>	<p>Low He/dpa ratio</p>
Spallation	<p>Allows high-He irradiation conditions to be explored</p> <p>Operating costs may be largely provided by non-fusion agencies</p>	<p>Not designed for materials irradiations (physics/ neutron scattering facility)*</p> <p>He/dpa,H/dpa ratio too high</p> <p>Pulsed irradiation; requires detailed analysis</p>
D-Li	<p>Correct He/dpa ratio, etc.</p> <p>Dedicated materials irradiation facility</p>	<p>Operating funds completely provided by fusion</p>

**\*feasibility of limited-volume “rabbit” irradiation facility in SNS is being explored**

# Fusion Neutron Source

---

## **Mission:**

- (i) Qualification of candidate materials up to about full lifetime of anticipated use in a fusion DEMO reactor**
- (ii) Calibration and validation of data generated from fission reactors and particle accelerators**
- (iii) Identify possible new phenomena which might occur due to the high energy neutron exposure**

# Requirements for an Intense Neutron Source

(IEA-Workshop in San Diego 1989)

---

- 1. Neutron flux/volume relation:** Equivalent to 2MW/m<sup>2</sup> in 10 L volume  
[1 MW/m<sup>2</sup>  $\cong$  4.5x10<sup>17</sup> n/m<sup>2</sup>s; E = 14 MeV, 3x10<sup>-7</sup> dpa/s for Fe]
- 2. Neutron spectrum:**
  - Should meet FW neutron spectrum as near as possible
  - Quantitative criteria are: Primary recoil spectrum (PKA)
  - Important transmutation reactions (He, H)
- 3. Neutron fluence accumulation:**  
Demo-relevant fluence 150 dpa<sub>NRT</sub> in few years
- 4. Neutron flux gradient:**  $\leq 10\%/cm$
- 5. Machine availability:** 70%
- 6. Time structure:** Quasi continuous operation
- 7. Good accessibility** of irradiation volume for experiments & instrumentation

---

*1 MWy/m<sup>2</sup>  $\cong$  10 dpa<sub>NRT</sub> for Fe*

# Overview of IFMIF

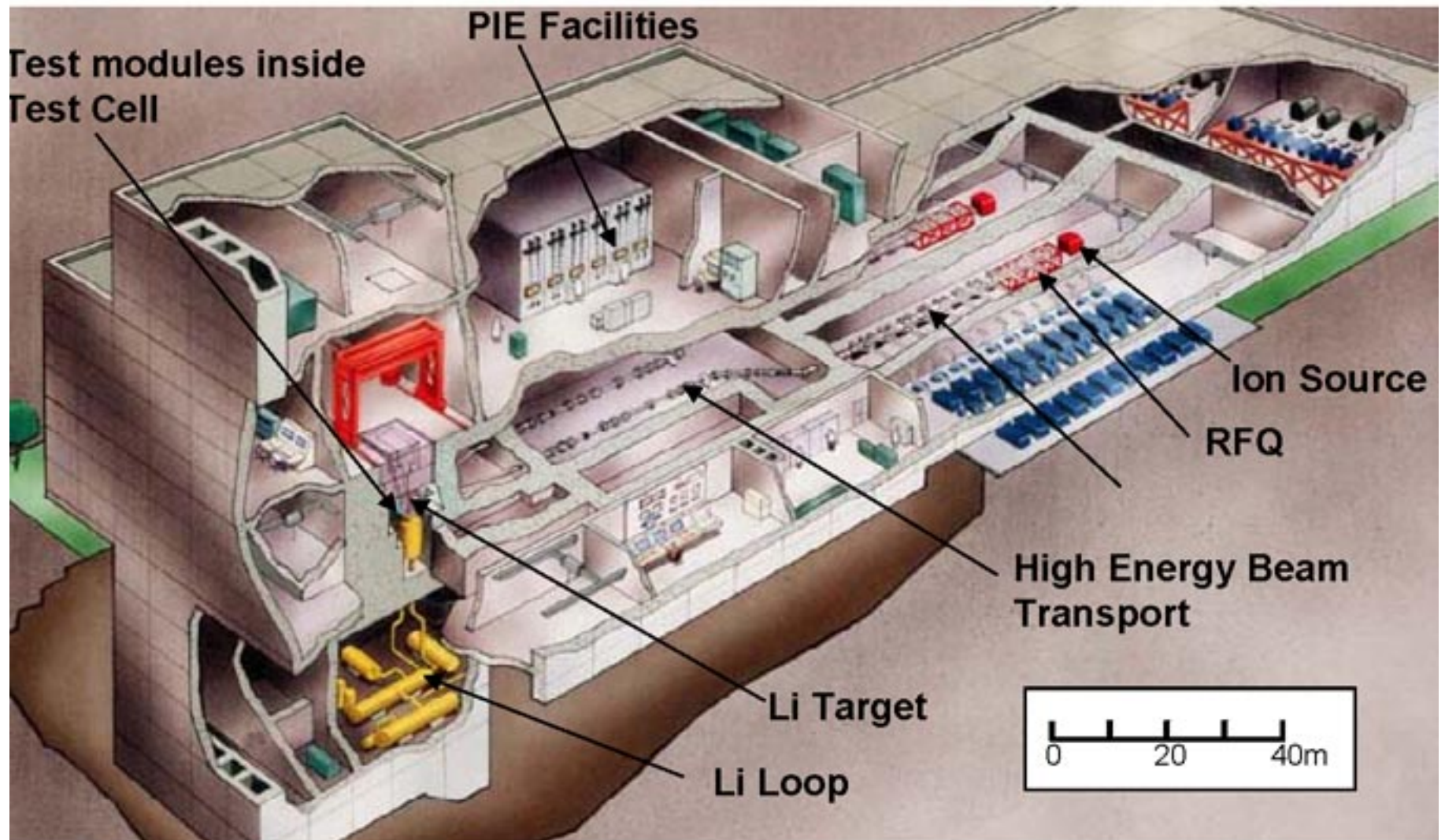

A. Möslang, FZK-Karlsruhe, 2002



# IFMIF target and test cell

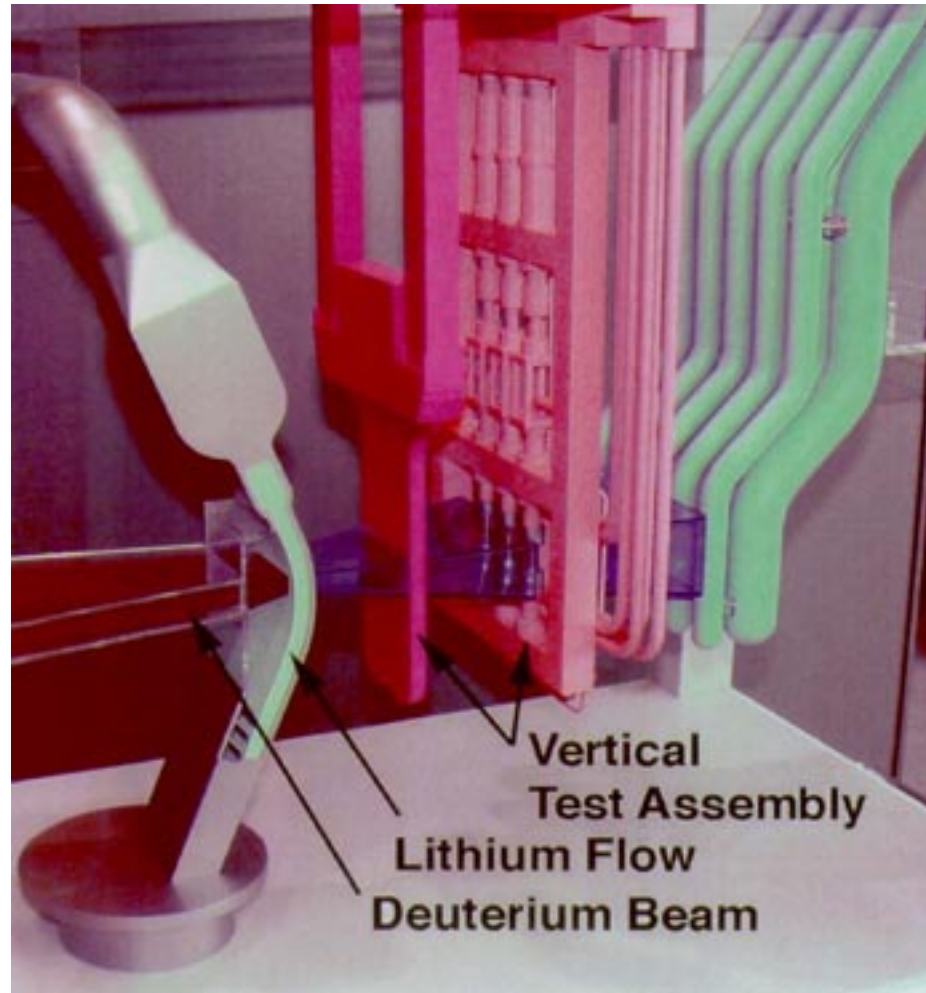

*A. Möslang, FZK-Karlsruhe, 2002*

# Sensitivity of damage to PKA spectra

## Comparison of different neutron sources

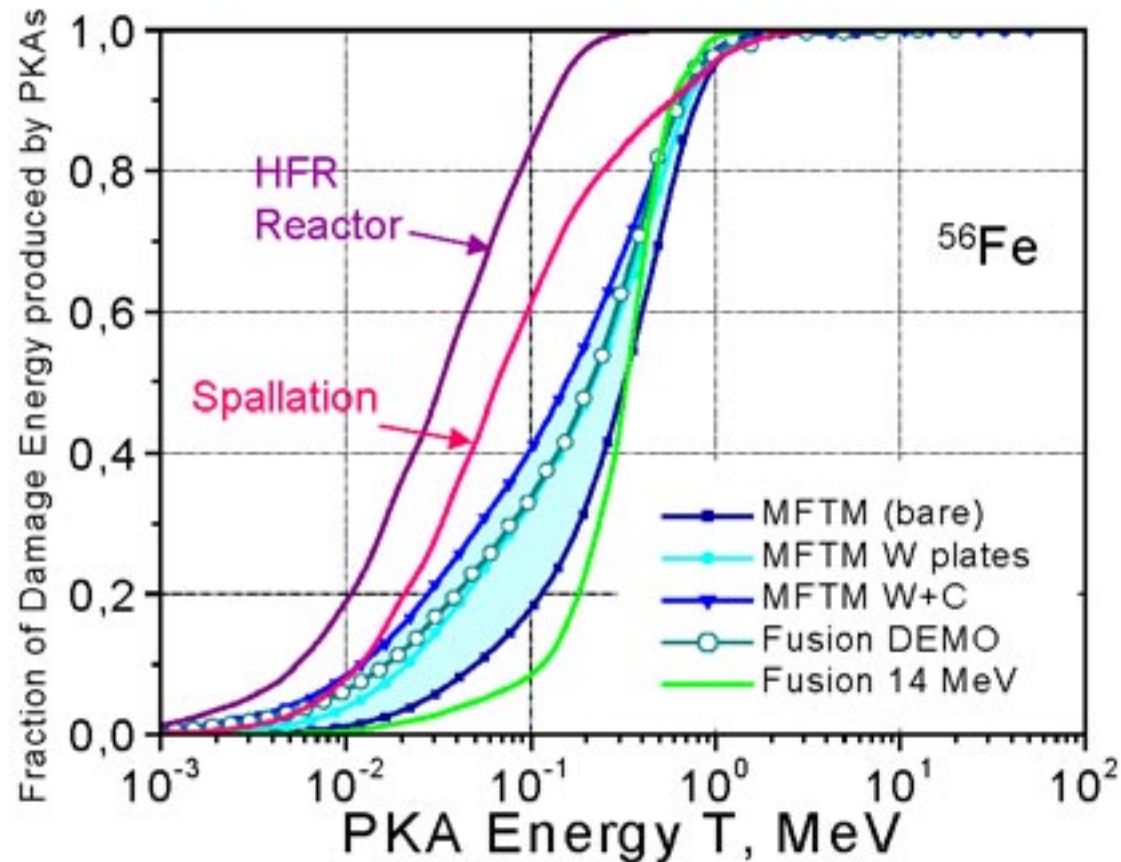

IFMIF (hatched area) meets perfectly the conditions of DEMO-reactor blankets

A. Möslang, FZK-Karlsruhe, 2002



# Comparison of different radial damage profiles

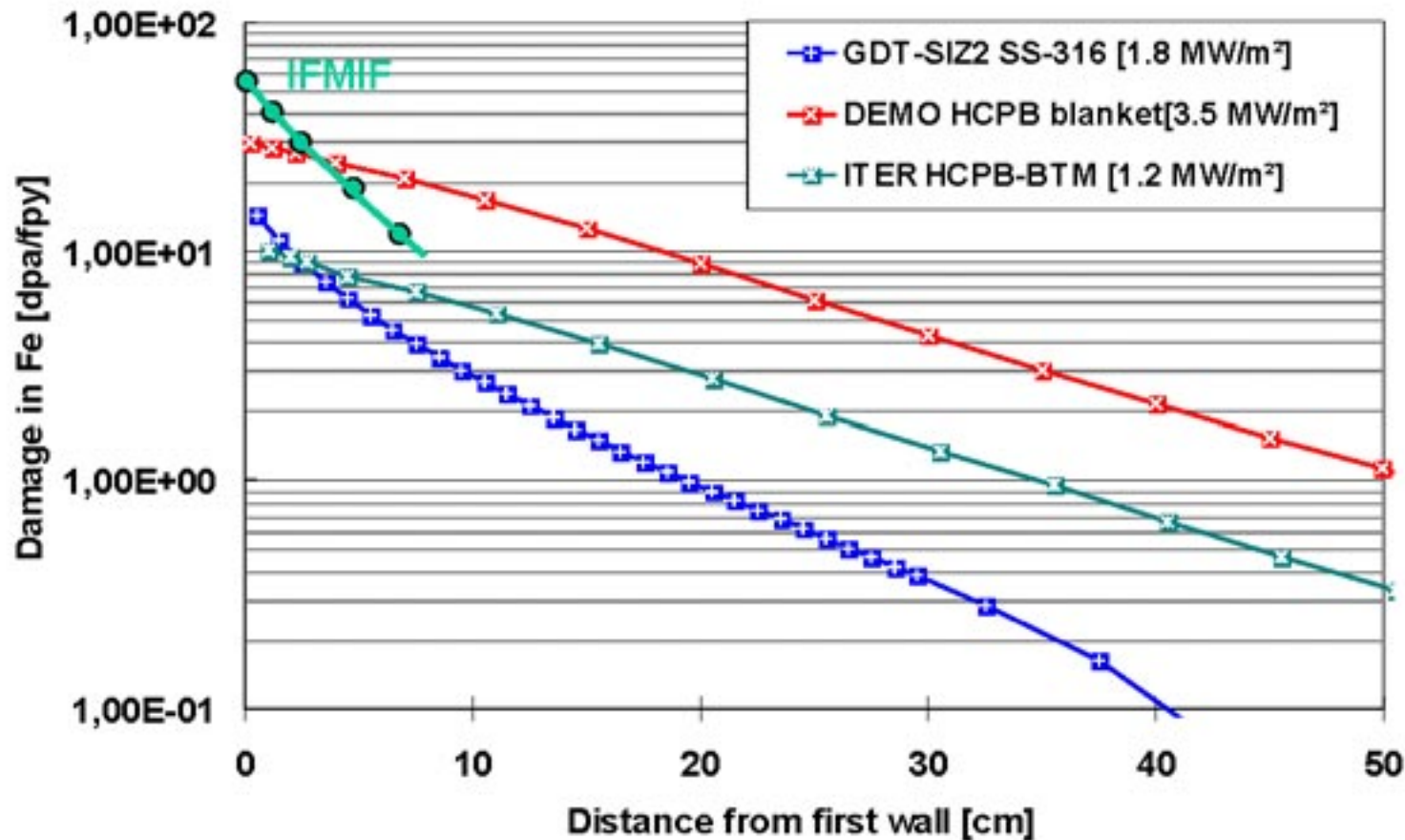

Flux gradients requires miniaturized specimens in all non-volume sources

# Validated Miniaturized Specimens Enable Engineering Data to be Obtained from Small Irradiation Volumes (currently used in extensive fission reactor studies)

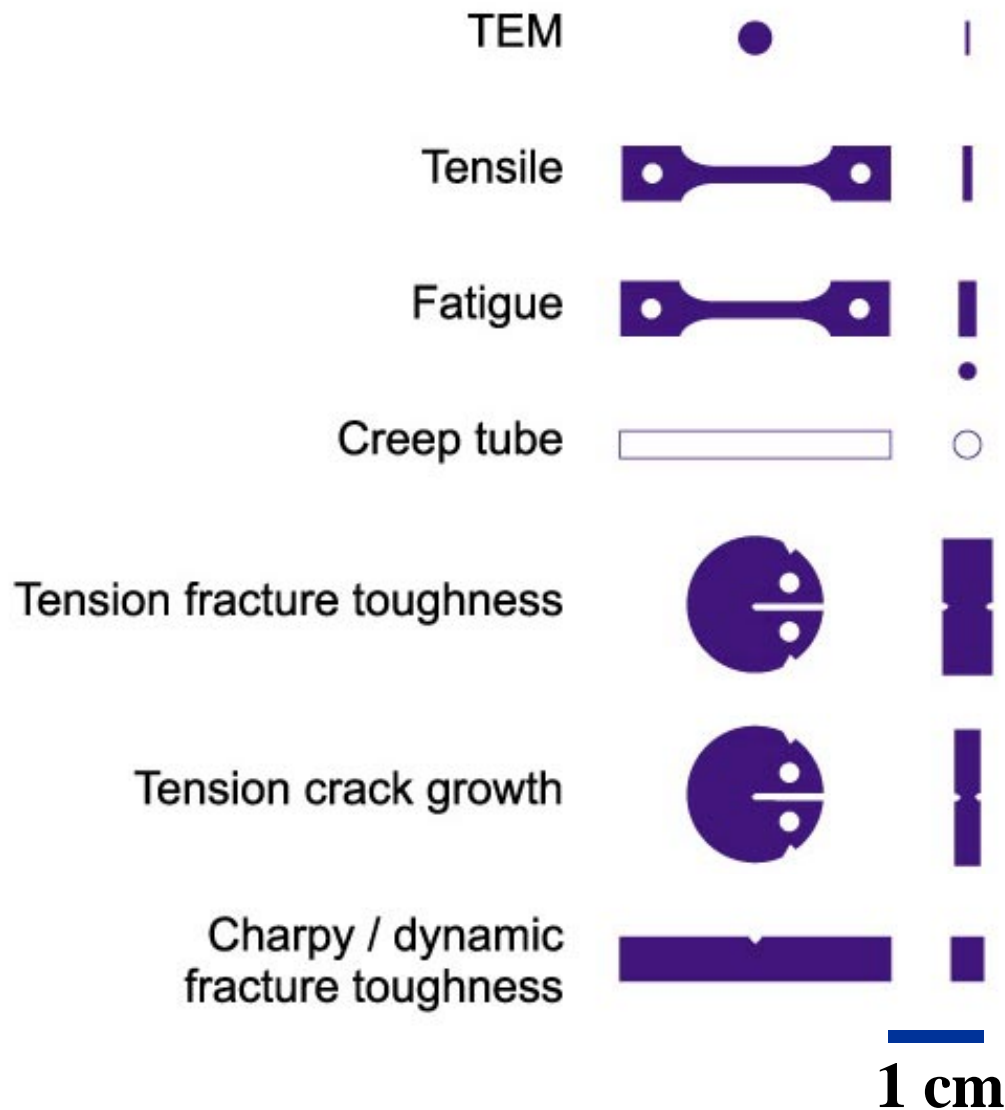

## IFMIF High Flux Position ( $\geq 20$ dpa/fpy) Material test samples in a reference module

Type of Specimen	Geometry (mm)	No of Specimens*	Volume of packets (cm <sup>3</sup> )
Microstructure	TEM disk (3 diam. × 0.25)	800	4
Tensile	Sheet tensile specimens (25 × 4.8 × 0.76)	156	45
Fatigue	Cylindrical specimens (25 × 4.8 × 1.52)	96	56
Fracture toughness	Disk compact tension (11.5 × 11.5 × 4.6)	66	89
Crack growth	Disk compact tension (11.5 × 11.5 × 2.3)	40	32
Dyn. fracture toughness	Notched bar (3.3 × 3.3 × 25)	120	62
Creep	Pressurized tube (25 × 2.5 diam.)	104	37
<b>Total</b>		<b>1382</b>	<b>325</b>

\* Dimensions were determined according to standard packing arrangements used for fission neutron irradiation capsules

On the basis of SSTT, ~0.5 liter (20-50 dpa/fpy) is sufficient to get within 15-20 years a representative test matrix up to about 150 dpa for a variety of materials

# Summary of Typical Reference High-flux Specimen Matrix for One Alloy at Each Irradiation Temperature

Property	Multiplicity at each irradiation condition	Volume occupied* (cm <sup>3</sup> )	% of total volume
Microstructure/swelling	≥5	0.025	0.2%
Tensile	4-6	1.2	10%
Fatigue	4	2.3	18%
Fracture toughness	3	4.0	32%
Crack growth	2	1.6	13%
Bend bar/ dynamic fracture toughness	≥4	2.0	16%
Creep	≥4	1.4	11%

Total: 12.5 cm<sup>3</sup>

\*includes packaging volume

# IFMIF Reference Specimen Test Matrix (1996)

Table 1. IFMIF Test Matrix / Materials		
Materials	Dose (dpa)	Temperature (°C)
FM1, FM2, FM3*, I1, I2*	20-150	300
FM1, FM2, FM3*, Van1, Van2, Van3*, I1, I2*, SiC1	20-150	400
FM1, FM2, FM3*, Van1, Van2, Van3*, I1, I2*	20-150	500
Van1, Van2, Van3*, SiC1, SiC2, I3	20-150	600
SiC1, SiC2, I3	20-150	800
SiC1, SiC2, I3	20-150	1000

		Number of heats
FM1, FM2, FM3*	Ferritic/martensitic steel	3
Van1, Van2, Van3*	Vanadium alloys	3
SIC1, SIC2	SiC/SiC composites	2
I1, I2*, I3	Innovative alloys	4
	Total	12

# IFMIF Reference Irradiation Schedule (1996 CDA)

## Time (years)

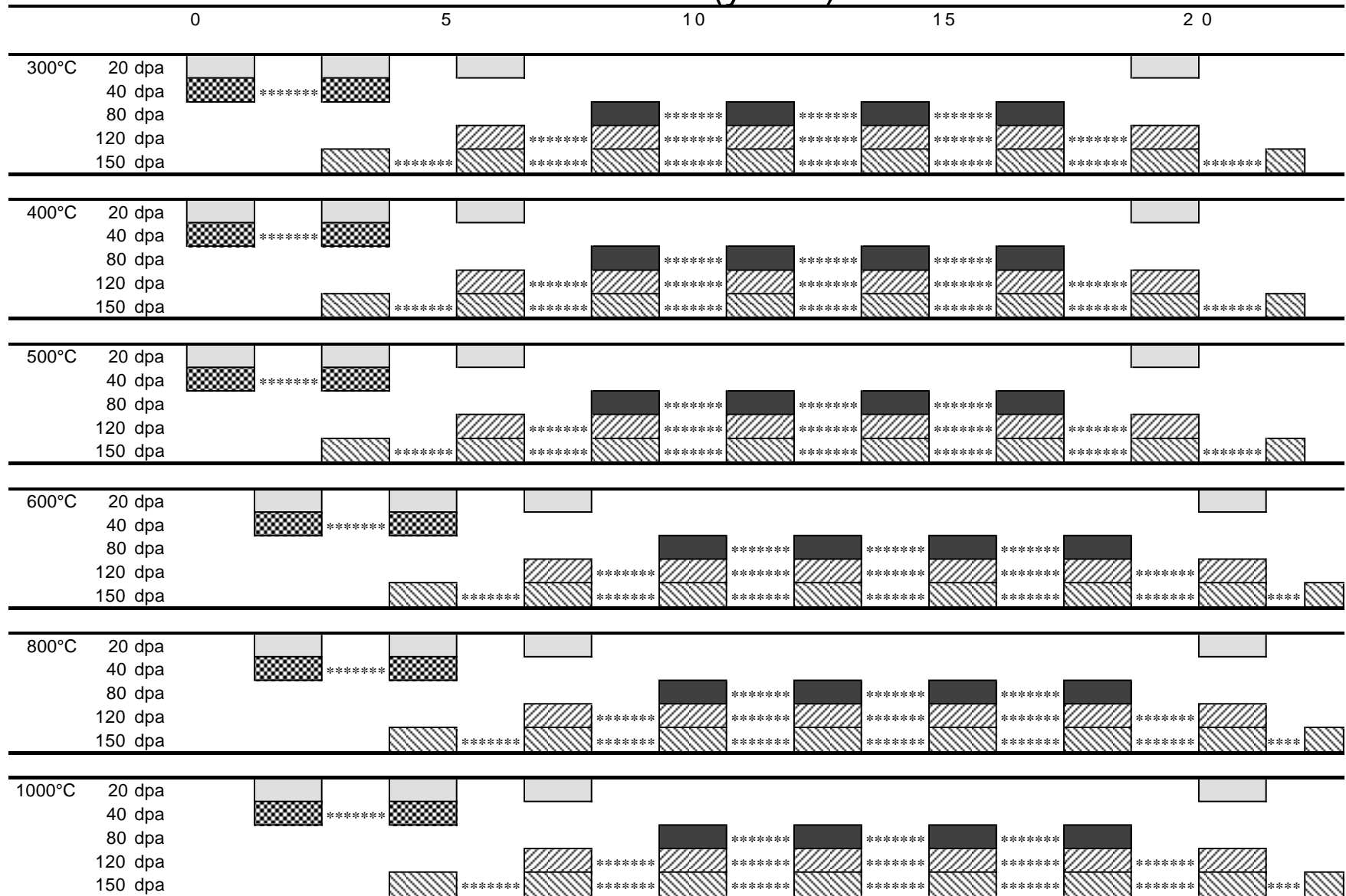

## IFMIF provides capability of accelerated radiation effects testing of structural materials in a fusion-relevant neutron spectrum

- ~0.5 liter volume with  $>2$  MW/m<sup>2</sup> equivalent neutron flux (~5x20x5 cm<sup>3</sup>)
  - ~0.1 liter volume with  $>5.5$  MW/m<sup>2</sup>
  - (note: typical current fission reactor irradiation capsule volumes are 0.013 to 0.1 liters)
- Strawman specimen matrices indicate that 600-1000 mechanical property specimens (and  $\gg 1000$  TEM specimens) can be accommodated in 0.5 liter high flux region
- Irradiation to 15-20 MW-a/m<sup>2</sup> of a complete set of mechanical property specimens of two materials at 3 to 4 different temperatures could be accomplished in 4 years in the  $\geq 5.5$  MW/m<sup>2</sup> flux regions of IFMIF
- Medium and low-flux regions of IFMIF ( $<2$  MW/m<sup>2</sup>) are earmarked for in-situ creep fatigue tests, ceramic breeder irradiation studies, diagnostic component irradiations, etc.



# IFMIF Creep-fatigue & T-release Test Modules

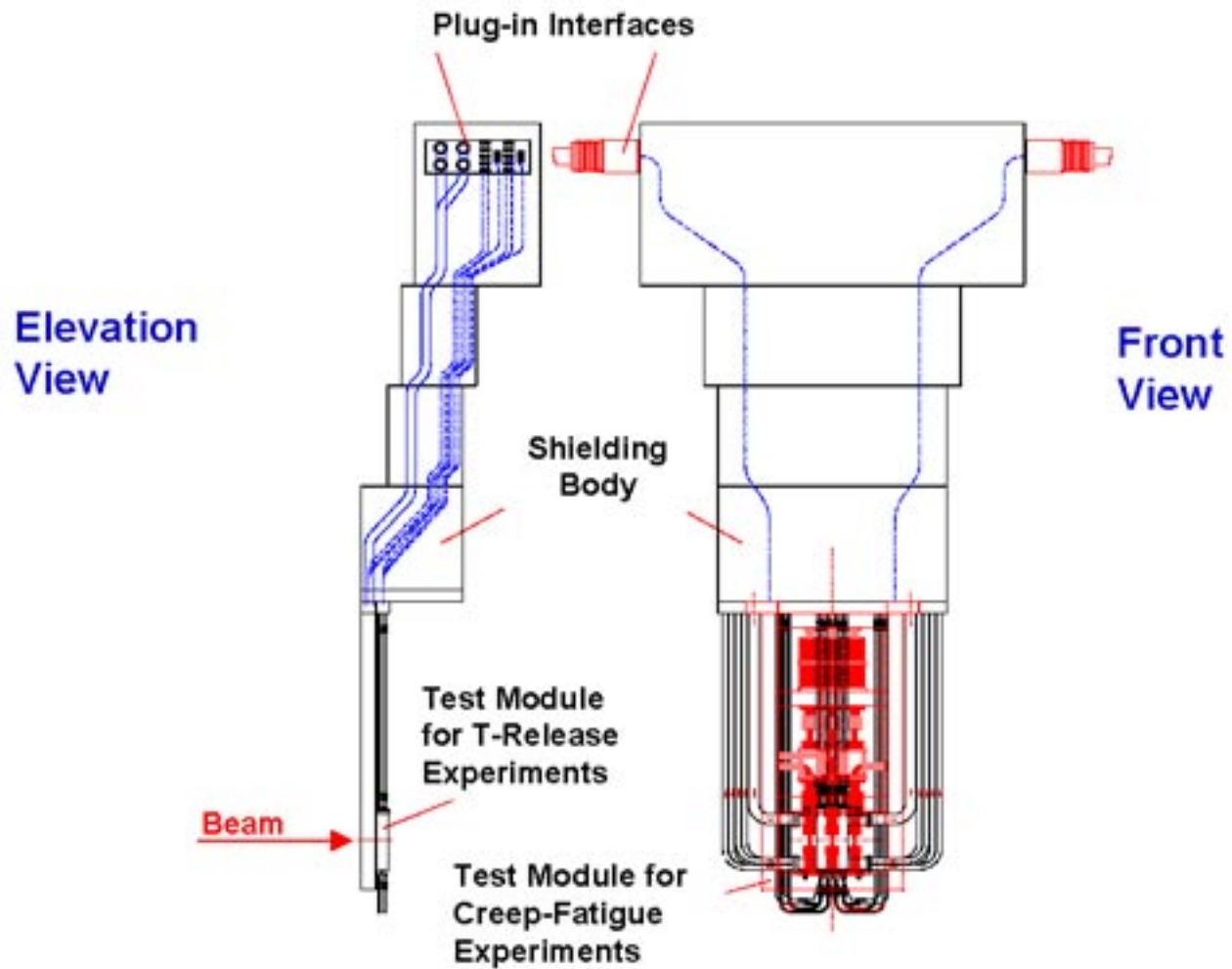

A. Möslang, FZK-Karlsruhe, 2002

# Strategy for Deployment Schedule of Fusion Materials intense neutron irradiation facility (IFMIF)

- Acquisition of the fundamental constitutive properties of irradiated materials is essential for the analysis of the performance of irradiated components
- Development of materials will likely require several iterations of materials irradiation & alloy modification (requiring >15-20 years to develop and qualify materials)
- IFMIF should be deployed in advance of a plasma technology test bed (strong interactions between users of each facility are essential)
  - Cf. Snowmass 2002 report and Wednesday Aug. 28 discussion

# IFMIF Planning

Working group, March 2002,

Draft EU Proposal

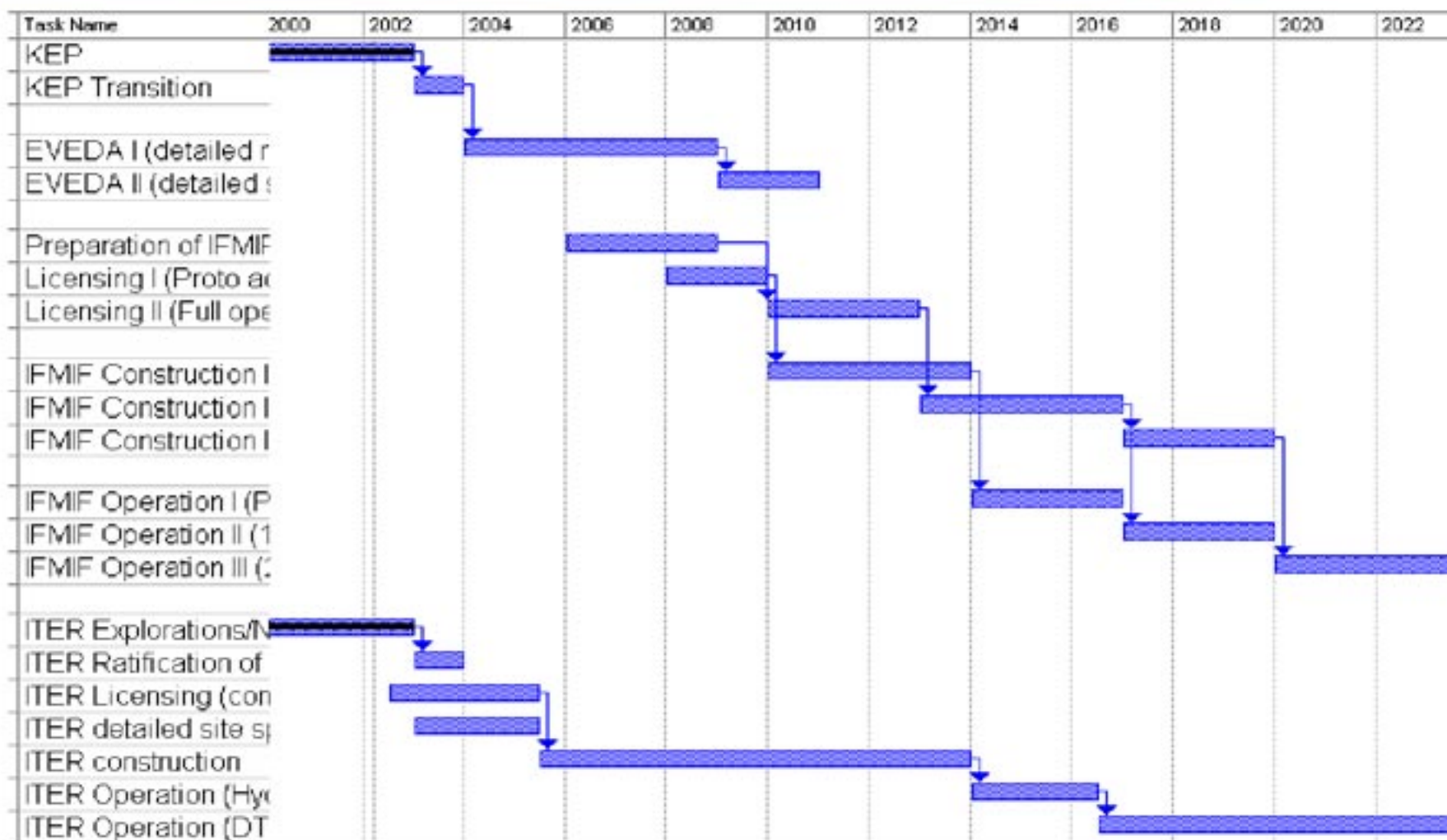

A. Möslang, FZK-Karlsruhe, 2002

# How much could the rate of fusion materials development be accelerated with more funding?

- The 1978 Fusion Reactor Materials Program Plan (DOE/ET-0032/1) projected that the engineering data base and performance limits for up to four candidate materials could be established within a period of 25 years
  - Assumed slowly growing budgets (1978 fusion materials budget was >3 times larger than 1998-2003 annual budgets)
- Based on improved knowledge base (compared to 1978), it would be feasible to propose that a materials class might be qualified for Demo within a period of ~20 years, if design and construction of an appropriate neutron source is initiated immediately
  - Assumes appropriate fusion materials budget, so that parallel activities on joining, compatibility, etc. can be pursued in addition to neutron irradiation tasks

# Conclusions

- Reduced activation materials with properties comparable or superior to conventional materials have been developed by the international fusion materials community
- Fusion materials R&D efforts have led to the development of materials with good radiation resistance during fission reactor irradiation up to 10-50 dpa and higher
  - These materials would likely have good performance in a fusion neutron environment for doses up to ~10 dpa
- The main uncertainty is the microstructural evolution and property degradation that may occur for fusion neutron exposures above ~10 dpa (~100 appm He)
- Ferritic/martensitic steels are the most technologically advanced option, so they are the leading international candidate for Demo
- V alloys offer the potential for improved performance compared to F/M steels, but require further alloy development to reach their full potential
- SiC/SiC composites have the highest temperature capability, but are the least developed of the three main structural material classes

## Conclusions, *continued*

- It is generally assumed that 3 to 4 iterations of irradiation followed by materials compositional modification will be needed to develop fusion structural materials for Demo (~20 to 30 years total elapsed time)
  - Testing can be accelerated by concentrating on select leading candidates in a high-flux fusion neutron irradiation source with a minimum volume of ~100 cm<sup>3</sup> (e.g., the highest-flux regions in IFMIF)

# Backup Viewgraphs



# IFMIF Reference Test Matrix: Type SF1 Fatigue Specimens

Materials	Dose (dpa)	Temperature (°C)	No. of specimens*	No. of packets**
FM1, FM2	20	300	8	4
I1	20 (2nd set)		4	2
FM1, FM2, I1	40		12	6
FM1, FM2, I1	80		12	6
FM1	120		4	2
FM1	150		4	2
FM1, FM2, Van1, Van2	20	400	16	8
I1, SiC1	20 (2nd set)		8	4
FM1, FM2, Van1, Van2, I1, SiC1	40		24	12
FM1, FM2, Van1, Van2, I1, SiC1	80		24	12
FM1, Van1	120		8	4
FM1, Van1	150		8	4
FM1, FM2, Van1, Van2	20	500	16	8
I1	20 (2nd set)		4	2
FM1, FM2, Van1, Van2, I1	40		20	10
FM1, FM2, Van1, Van2, I1	80		20	10
FM1, Van1	120		8	4
FM1, Van1	150		8	4
Van1, Van2, SiC1, SiC2	20	600	16	8
I3	20 (2nd set)		4	2
Van1, Van2, SiC1, SiC2, I3	40		20	10
Van1, Van2, SiC1, SiC2, I3	80		20	10
Van1, SiC1, SiC2	120		12	6
Van1, SiC1	150		8	4
SiC1, SiC2	20	800	8	4
I3	20 (2nd set)		4	2
SiC1, SiC2, I3	40		12	6
SiC1, SiC2, I3	80		12	6
SiC1, SiC2	120		8	4
SiC1, SiC2	150		8	4
SiC1, SiC2	20	1000	8	4
I3	20 (2nd set)		4	2
SiC1, SiC2, I3	40		12	6
SiC1, SiC2, I3	80		12	6
SiC1, SiC2	120		8	4
SiC1, SiC2	150		8	4

## IFMIF Medium Flux Region: In-situ creep-fatigue test module

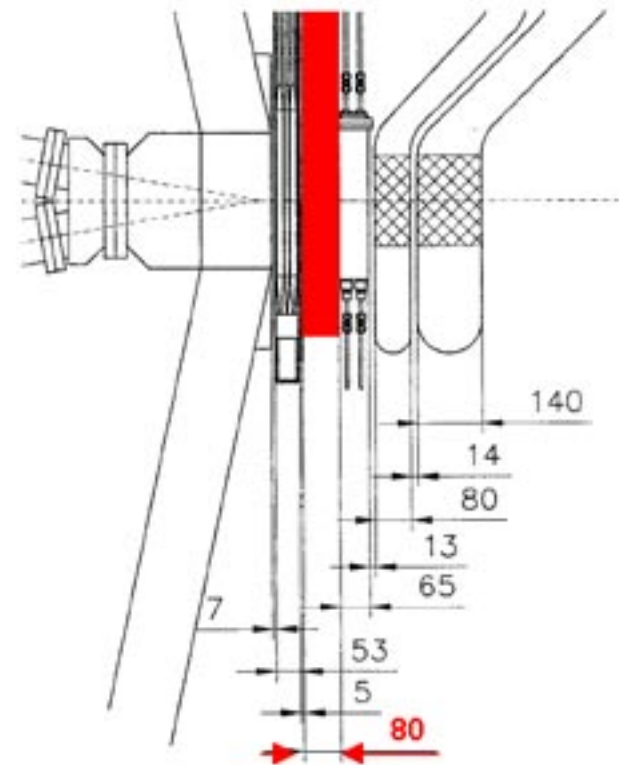
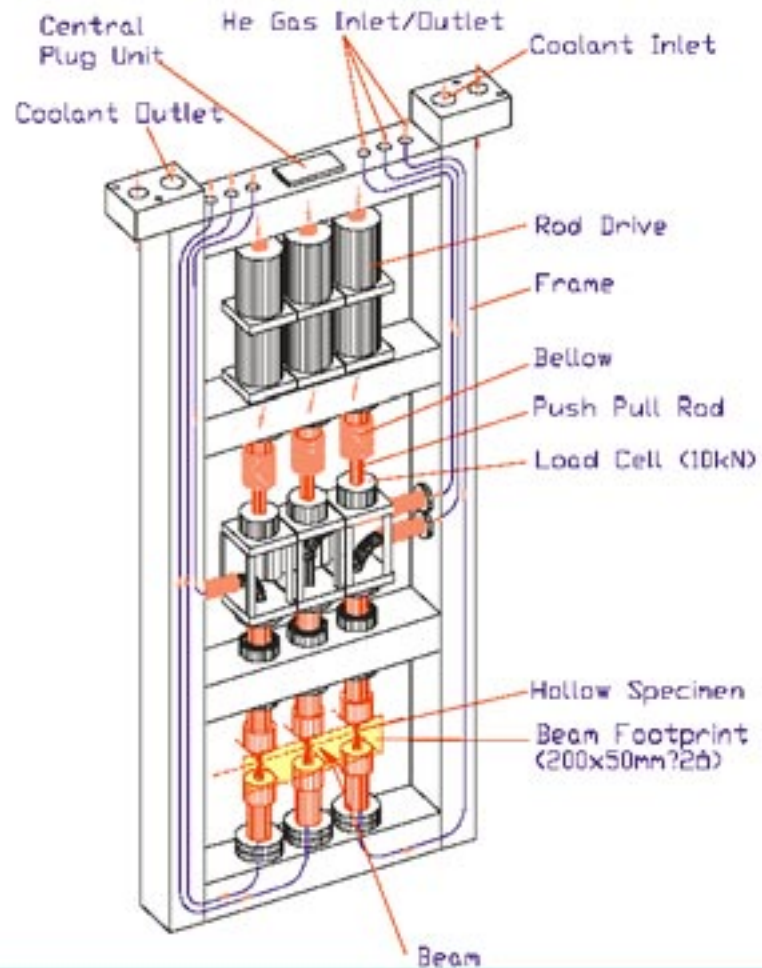

# IFMIF provides correct neutron spectrum for fusion materials

SPECTER calculations for damage and transmutation products using First Wall spectra provided by 3D Monte Carlo calculations

MWy/m <sup>2</sup>	ITER			DEMO		
	damage (dpa)	He (appm)	H (appm)	damage (dpa)	He (appm)	H (appm)
Fe	20	228	890	17	180	709
Cr	20	361	905	18	282	722
Ni	21	790	3994	19	634	3222
V	21	114	477	18	89	374
Be	6.9	6510	98	6.9	5424	76
C	9.4	4302	1.2	9.2	3371	0.9
Si	27	860	1912	24	692	1524

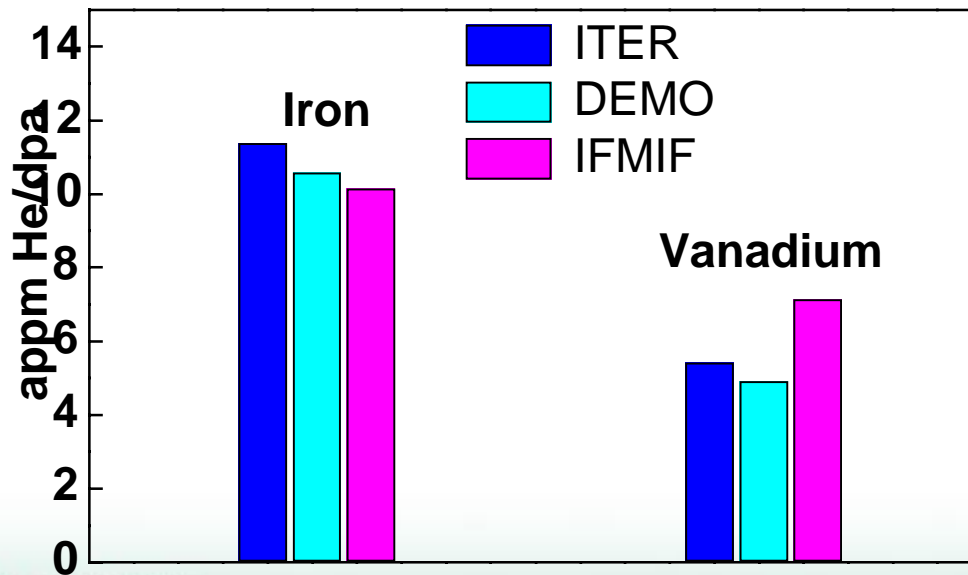

Ehrlich et al.  
ICFRM9 1999

## IFMIF PIE Facility Layout

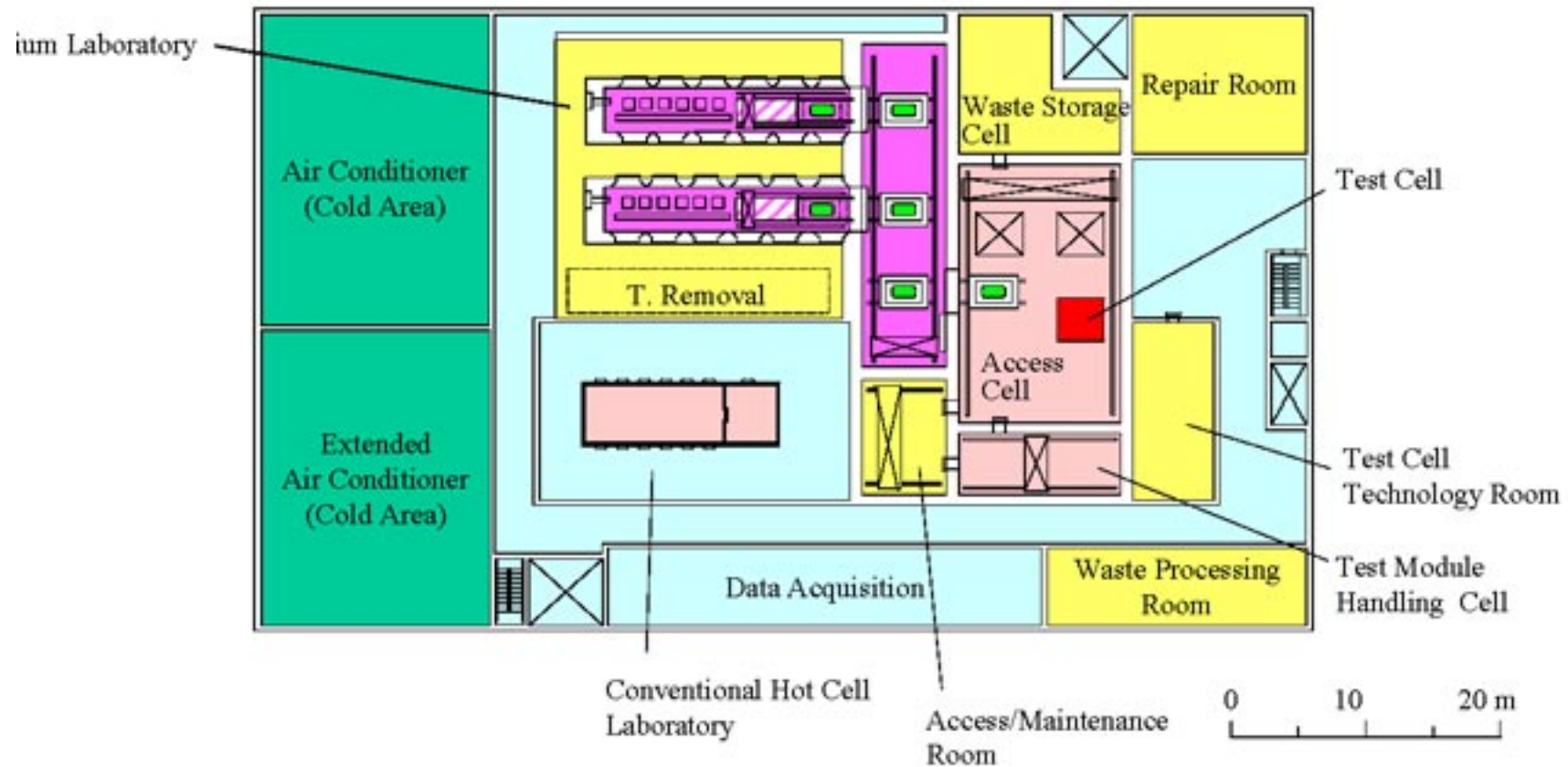

The IFMIF site is equipped with complete Post Irradiation Examination laboratories

*A. Möslang, FZK-Karlsruhe, 2002*